



Pentax DSI-400 Series Frequency Inverter



Users Manual



Foreword

Thank you for using the DSI-400 series of high-performance vector inverter.

New DSI-400 series is a general current vector control inverter integrated with the performance and features in a high degree.

DSI-400 with industry-leading drive performance and functionality control, using unique current vector control algorithm can efficiently drive induction motor to achieve high accuracy, high torque and high-performance control.

Customer success, Market Service! DSI-400 in terms of performance and control are worthy of trust!

This guide explains how to properly use DSI-400 series inverter. Before using (installation, operation, maintenance, inspection, etc.), be sure to carefully read the instructions. Understanding of product safety precautions before using this product.

General notes

- This manual due to product improvement, specifications change, as well as to the instructions of their ease of use will be appropriate changes. We will update the information number of instructions, issued a revised edition.
- Due to damage to or loss need to order the manual, please contact HNC or HNC agents to order it as per the information number on the cover.
- This icon in the instructions with the products you ordered may be different, please refer to the specific documentation for products supplied.

Definition of security

In this manual, safety issues are the following two categories:



Warning: Due to the dangers posed against the required operation, may result in serious injury and even death;



Caution: Due to the dangers posed against the required operation, may lead to moderate harm or minor injuries, and damage to the equipment;

Installation, commissioning and maintenance of the system, please carefully read this chapter (safety precautions), follow the required safety precautions to operate. HNC is not responsible in case of any injuries and losses caused as a result of improper operations.



Safety precautions

Before Installation



Do not install inverter finding the control system with water in, or inverter with missing parts or damaged parts.

Please do not install inverter when the packing list is not consistent with the physical name.



Carefully handled when loading, otherwise it may damage the inverter.

Please don't use the damaged driver or missing parts inverter, there may be risk of injury.

Do not touch components of the control system, otherwise it will cause danger of static electricity.

During Installation



Mount the inverter on incombustible surface like metal, and keep away from flammable substances. Otherwise it may cause fire.

Do not twist the mounting bolt of the equipment, especially the screw bolt marked in RED.

Prohibit the use in the dangerous environment where inflammable or combustible or explosive gas, liquid or solid exists. Or it may cause electric shock or fire.



Do not drop the conducting wire stub or screw into the inverter. Otherwise ,it may cause

damage to the inverter.

Please install the inverter at the place of less direct sunlight and vibration.

Please mind the location of its installation when more than two inverters are installed in one cabinet, so that radiation effect is promised.

During Wiring



Operation shall be performed by the professional engineering technician. Otherwise there will be unexpected danger.

There shall be circuit breaker between the inverter and power supply. Otherwise, there may be fire.

Make sure the power is disconnected prior to the connection. Otherwise there will be danger of electric shock.

The earth terminal shall be earthed reliably. Otherwise there may be danger of electric shock.



Please don't put the power line and the signal line from the same pipeline, when operating wiring, please make power line and signal line apart above 30cm.

The encoder must use shielded cable, and the shield must ensure that a single side of a reliable ground!

Do not connect the input power cable to the output terminals(U、V、W).Attention to the terminals of the mark and do not make wrong connection. Otherwise it may damage the inverter.

The brake resistor must be connected between the terminals (P+)、(PB). and never connect to DC bus terminals (P+)、(P-) , otherwise it may cause fire.

Ensure the wiring meet the EMC requirements and the local safety standard.

The wire size shall be determined according to the manual. Otherwise, accident may be caused!

Before Power-on:



Caution

Any part of the inverter need not to carry on pressure test,which has been done before leaving factory.Or accident may be caused.

Please confirm whether the power voltage class is consistent with the rated voltage of the inverter and the Input terminal (R、 S、 T) and Output terminal(U、 V、 W)cable connecting positions are correct, and check whether the external circuit is short circuited and whether the connecting line is firm,otherwise it may damage the inverter.

Do not frequently turn ON/OFF power .If continuously ON/OFF power is needed, please make sure the time interval more than 1 minute.



Caution

The cover must be well closed prior to the inverter power-on. Otherwise electric shock may be caused!

All the external fittings must be connected correctly in accordance with the circuit provided in this manual.Or accident may occur.

Upon Power-on



Warning

Do not open the cover of the inverter upon power-on.Otherwise there will be danger of electric shock!

Do not touch the inverter and its surrounding circuit with wet hand. Otherwise there will be danger of electric shock.

Do not touch the inverter terminals (including control terminal). Otherwise there will be danger

of electric shock.

At power-on, the inverter will perform the security check of the external strong-current circuit automatically. Thus, at this time please do not touch the terminals U、 V、 W, or the terminals of motor, otherwise there will be danger of electric shock.

If the parameter identification is required, pay attention to the danger of injury arising from the rotating motor. Otherwise accident may occur.

Do not change the factory settings at will. Otherwise it may damage the equipment.

During the Operation

Warning

Do not touch the fan, heat sink or discharge resistor to sense the temperature. Otherwise, you may get burnt.

Detection of signals during the operation shall only be conducted by qualified technician. Otherwise, personal injury or equipment damage may be caused.

Cautions

Do not control run/stop by using contactor. Or equipment damage may be caused!

Avoid anything falling into the equipment when inverter is running.Or damage may be caused.

Maintenance

Warning

Do not carry out repairs and maintenance of equipment with power on. Otherwise, there is a risk of electric shock!

No specially trained personnel can not make inverter implementation of repairs and maintenance. Otherwise, personal injury or equipment damage may be caused!

Make sure the inverter when the inverter voltage is lower than AC36V implementation of the maintenance and repair, five minutes after power prevail. Otherwise, the residual charge on the capacitor will cause damage!

Make the inverter parameter settings, only with all pluggable plug in and out in the case of power outages!



Precautions

●Motor Insulation Inspection

Motor in use for the first time, placed a long time before re-use and periodic inspection should be done, the motor insulation should be checked, to prevent the motor winding insulation failure and damage to the inverter. To motor insulation check connection separate from the inverter, 500V megger is recommended, should ensure that the measured insulation resistance of not less than 5MΩ.

●Motor Thermal Protection

If the rated capacity of the motor Yes not match those of the inverter, especially when the rated power of the inverter is higher than the rated power of the motor, be sure to adjust the inverter motor protection parameter values , or thermal relay shall be mounted for motor protection.

●Running with Frequency higher than Power Frequency

This inverter can provide output frequency from 0Hz to 3200Hz. If the customer is required to run 50Hz above, consider the mechanical endurance of the device.

●Vibration of Mechanical Device

The inverter may encounter the mechanical resonance point at certain output frequencies, which can be avoided by setting the skip frequency parameters in the inverter.

●Motor Heat and Noise

Since the output voltage of inverter is PWM wave and contains certain harmonics, the temperature rise, noise and vibration of the motor comparing with the power frequency will be increased slightly.

●Use with the voltage different with the rated voltage

If the DSI-400 series inverter is used outside the allowable working voltage range as specified in this manual, it is easily lead to the inverter devices damage. If needed, use the corresponding boost or lower voltage transformer processing.

●The output side with the pressure-sensitive devices or to improve the power factor capacitor

Since the inverter output is PWM wave, the output side if installed with capacitors to improve the power factor or lightning varistors. Easily lead to the inverter instantaneous overcurrent or even damage the drive, do not use.

●Switching Devices like Contactors Used at the Input and Output terminal

If a contactor is installed between the power supply and the input terminal of the inverter, it is not allowed to use the contactor to control the startup/stop of the inverter. Necessarily need to use the contactor control inverter start and stop of not less than an hour. Frequent charge and discharge will reduce the service life of the capacitor inside the inverter. If switching devices like contactor are installed between the output terminal and the motor, should ensure that the inverter output off operation, otherwise easily lead to the inverter module damage.

●Change Three-phase Input to Two-phase Input

It is not allowed to change the DSI-400 series three-phase inverter into two-phase. Otherwise, it may cause fault or damage to the inverter. This operation must be handed under HNC technical guidance.

●Lightning Surge Protection

The series inverter has lightning over current protection device, and has certain self-protection ability against the lightning. In applications where lightning occurs frequently, the user shall install additional protection devices in front of the inverter.

●Altitude and Derating Use

Altitude of over 1000m of the region, the heat sink's cooling effect of the inverter may turn poorer due to the thin air. Therefore, it needs to derate the inverter for use. This case please contact our technical advice.

●Some Special Use

If the user needs to use the inverter with the methods other than the recommended wiring diagram in this manual, such as DC bus, please consult our company.

●Cautions of Inverter scrapped

The electrolytic capacitors on the main circuit and the PCB may explode when they are burnt. Emission of toxic gas may be generated when the plastic parts are burnt. Processed as industrial waste.

●Adaptable Motor

1) The standard adaptable motor is four-pole squirrel-cage asynchronous induction motor or permanent magnetic synchronous motor. If such motor is not available, be sure to select adaptable motors in according to the rated current of the motor.

2) The cooling fan and the rotor shaft of the non-frequency-conversion motor adopt coaxial connection. When the rotating speed is reduced, the heat sink cooling effect will be reduced. Therefore, overheating occasions should be retrofitted with a strong exhaust fan or replace the variable frequency motor.

3) Since the inverter has built-in standard parameters of the adaptable motors, it is necessary to perform motor parameter identification or modify the default values so as to comply with the actual values as much as possible, or it may affect the performance and protective properties.

4) Since short circuit cable or internal circuit of motor may cause alarm, or even machine explosion, please do insulation and short circuit test before the initial use as well as daily maintenance. Note: be sure to do this test, inverter and tested parts must be all separated!



EMC Guidance

According to the national standard of GB/T12668.3, DSI-400 complys with the requirements for electromagnetic interference and anti-electromagnetic interference.

DSI-400 series inverter meet international standard as below,the products have passed CE certification.

IEC/EN 61800-5-1 : 2003 Safety Regulation on Commissionable Electric Drive System

IEC/EN 61800-3: 2004 Commissionable Electric Drive System

To obtain good electromagnetic compatibility in general industrial environment, please refer to the following instruction:

Installation of EMC guidance:

- 1) Ground wire of inverter and other electrical products should be well grounded.
- 2) Try not set parallel arrangement for inverter input/output power line and weak electric signal lines, set vertical arrangement if possible.
- 3) The inverter output power line is recommended to use shielded cable, or steel shielded power line, and shielding layer should be reliable grounded. Twisted pair shielded control cable is recommended for wiring of interference device.
- 4) If the distance between the inverter and the motor exceeds 100 meters, output filter or reactor shall be installed.

Input filter installation EMC guidance:

- 1) Note: The filters should strictly be used according to the rated value. As filter belongs to class I appliances, filter metal shell ground shold be large area well connected to installation cabinet metal gound, and good conductive continuity is required. Otherwise there will be risk of electric shock and serious impact on the EMC effect.
- 2) EMC test proves, filter and PE end must be connected to the same public ground, otherwise it will seriously affect the EMC effect.
- 3) Filter should be installed as close as possible to the inverter power supply input.

DSI-400 INVERTER

Section I. Product Information.....	1
1.1 Nameplate specification.....	1
1.2 Model specification	1
1.3 Product series.....	2
1.4 Product shape.....	4
1.4.1 Product Component Name.....	4
1.4.2 Product Outline, Mounting Dimension, and Weight	5
1.5 Standard specification.....	9
1.6 Interface configuration.....	12
Section II. Installation & Wiring.....	14
2.1 Use of the environment.....	14
2.2 Handling and installation.....	14
2.3 Lower cover removable and installation.....	16
2.4 Wiring.....	17
2.4.1 DSI-400 diagram	17
2.5 Main circuit terminals (G type).....	18
2.5.1 DSI-400 main circuit terminals	18
2.6 Control circuit terminals.....	18
2.6.1 Control circuit terminal arrangement	18
2.6.2 Control circuit terminals description	19
2.6.3 Description of wiring of control terminals	21
2.7 Standby circuit.....	23
Section III. Fittings	24
3.1 Connection with peripheral devices	24
3.1.1 Connection of the Product and Peripheral Devices	24
3.1.2 Peripheral Electric Parts of DSI-400	25
3.2 Mounting hole dimension.....	27
3.2.1 Braking unit & Braking resistance	27
3.2.2 Specifications of circuit breaker、cable and contactors	28
Section IV. Keyboard Operation	29
4.1 Keyboard size	29
4.1.1 DSI-400 keyboard specification	29
4.1.2 Keyboard warehouse JP3 dimension.....	29
4.2 Display Interface.....	30

4.1.2	Keyboard warehouse JP3 dimension.....	29
4.2	Display Interface.....	30
4.2.1	Function description of operation panel.....	30
4.3	Examples for parameter setting.....	32
4.3.1	Description of function code viewing and modification method.....	32
4.3.2	Parameter display mode.....	32
4.3.3	User set parameter operation mode.....	33
4.3.4	Check method of state parameter.....	34
4.3.5	Password Setting.....	34
4.3.6	Motor parameter automatic tuning.....	35
4.4	Test running.....	36
Section V.	Parameter Function Table.....	37
5.1	Monitor function group: U0.00-U0.61.....	37
5.2	Basic function group: P0.00-P0.28.....	42
5.3	Parameters for motor 1: P1.00-P1.37.....	51
5.4	Vector control function group: P2.00-P2.22.....	53
5.5	V/F control group: P3.00-P3.15.....	55
5.6	Input terminal: P4.00-P4.40.....	59
5.7	Output terminal: P5.00-P5.22.....	72
5.8	Start/stop control: P6.00-P6.15.....	76
5.9	Keyboard and display: P7.00-P7.14.....	80
5.10	Auxiliary function: P8.00-P8.53.....	83
5.11	Overload and protection: P9.00-P9.70.....	91
5.12	PID function group: PA.00-PA.28.....	100
5.13	Swing frequency, fixed length and counting: Pb.00-Pb.09.....	104
5.14	MS speed function & simple PLC function: PC.00-PC.51.....	106
5.15	Communication function group: Pd.00-Pd.06.....	110
5.16	User customization function code: PE.00-PE.29.....	111
5.17	Function code management: PP.00-PP.04.....	112
5.18	Torque control group: A0.00-A0.08.....	114
5.19	Virtual I/O: A1.00-A1.21.....	115
5.20	The second motor control: A2.00-A2.65.....	119
5.21	Control optimization : A5.00-A5.11.....	122
5.22	AI curve setup: A6.00-A6.29.....	123

5.23	User programmable card parameters: A7.00-A7.09	125
5.24	Point to point communication: A8.00-8.11	126
5.25	Extended function group: A9.00-A9.09	127
5.26	AI/AO correction: AC.00-AC.19	127
Section VI. Fault Diagnosis & Solutions		129
6.1	Fault alarm and solutions.....	129
6.2	Common fault and solutions.....	136
Section VII. Inspection & Maintenance.....		147
7.1	Inspection and Maintenance.....	147
7.2	Regular replacement of the device	148
7.3	Storage.....	148
7.4	Measuring and Judgment.....	148
7.5	Safety Precaution.....	148
Appendix I. RS485 Communication Protocol.....		149
I.1	H5RS485 card	149
I.2	Communication protocol.....	149
I.2.1	Protocol content.....	149
I.3	Protocol Description.....	149
I.4	Cyclical Redundancy Check	152
Appendix II. Parameter Settings List		160
Appendix III. Recommended accessories selection		181
1.	Brake unit braking resistor selection:	181
2.	Input AC reactor	182
3.	Output AC reactor	183
Product Feedback.....		185
Warranty Agreement.....		186

Section I. Product Information

HNC frequency inverters have been tested and inspected before leaving the manufacturer. Before unpacking the product, please check product packaging for shipping damage caused by careless transportation and whether the specifications and type of the product complies with the order. If any questions, please contact the supplier of HNC products, or directly contact the company.

- ※ Inspect that the contents are complete (one unit of DSI-400 frequency inverter, one operation manual).
- ※ Check the nameplate on the side of the frequency inverter to ensure that the product you have received is right the one you ordered.

1.1 Nameplate specification

1.2 Model specification

Variable Frequency Inverter
MODEL: DSI-400-1K5G3-00
POWER: 1.5KW
INPUT: 3PH 400V~ 5.2A 50Hz/60Hz
OUTPUT: 3PH 0-400V~ 3.7A 50HZ/60HZ
Pentax Inverter

DSI-400 – K75 G3-00

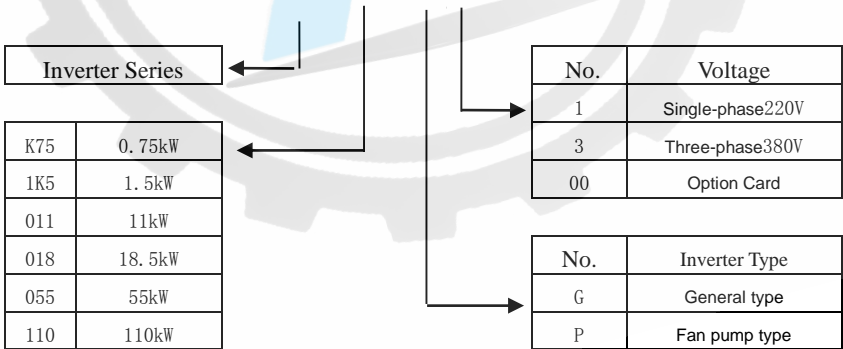

GP unification	Users check factory models through P0.00. P type is one lower power than G type.
Model description	E.g: If you need 11kW P type, 7.5kW G type could be selected as a replacement. Its input current is the rated input current (20.5A) of 7.5kW G type, but its rated power is that of 11kW G type, and output current is the rated output current(25A) of 11kW G type.

Though inverter hardware of GP unification is different, there are some optimization of software parameters for different load types .

P type model is only suitable for pump, fan etc light load models, can not work at the rated current or more than the rated frequency for a long time.

1.3 Product series

Inverter model	Motor adapter		Rated input A	Rated output A
	kW	HP		
1PH single phase input: AC 220V, 50/60Hz				
DSI-400-K40G1-00	0.4	0.5	5.9	2.5
DSI-400-K75G1-00	0.75	1	8.3	4
DSI-400-1K5G1-00	1.5	2	14.1	7
DSI-400-2K2G1-00	2.2	3	24.2	10
DSI-400-004G1-00	4.0	5.5	34.0	16
3PH 3-phase input: AC 380V, 50/60Hz				
DSI-400-K75G3-00	0.75	1	4.3	2.5
DSI-400-1K5G3-00	1.5	2	5.2	3.7
DSI-400-2K2G3-00	2.2	3	6.0	5
DSI-400-004G3-00	4.0	5	10.5	8.5
DSI-400-5K5G3-00	5.5	7.5	15.5	13
DSI-400-7K5G3-00	7.5	10	20.5	16
DSI-400-011G3-00	11.0	15	27.5	25
DSI-400-015G3-00	15.0	20	37.1	32
DSI-400-018G3-00	18.5	25	41.9	38
DSI-400-022G3-00	22	30	49.3	45
DSI-400-030G3-00	30	40	65.7	60
DSI-400-037G3-00	37	50	80.6	75

Section I. Product Information

DSI-400-045G3-00	45	60	96.4	90
DSI-400-055G3-00	55	70	117.6	110
DSI-400-075G3-00	75	100	166.4	150
DSI-400-093G3-00	90	125	184.3	170
DSI-400-110G3-00	110	150	226.8	210
DSI-400-132G3-00	132	175	268.1	250
DSI-400-160G3-00	160	210	321.1	300
DSI-400-187G3-00	185	245	368.0	340
DSI-400-200G3-00	200	260	406.6	380
DSI-400-220G3-00	220	300	442.7	415
DSI-400-250G3-00	250	350	503.0	470
DSI-400-280G3-00	280	370	555.9	520
DSI-400-315G3-00	315	500	650.7	600
DSI-400-355G3-00	355	420	734.5	650
DSI-400-400G3-00	400	530	787.6	725
DSI-400-450G3-00	450	595	846.0	820
DSI-400-500G3-00	500	670	885.0	860

Table 1-3

1.4 Product shape

1.4.1 Product Outline, Mounting Dimension, and Weight

DSI-400-K40G1 ~ DSI-400-2K2G1K, DSI-400-R75G3~ DSI-400-022G3/030P3 class

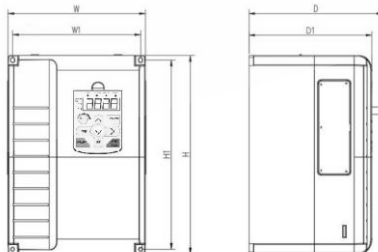

DSI-400-030G3/037P3~DSI-400-090G3/110P3 class

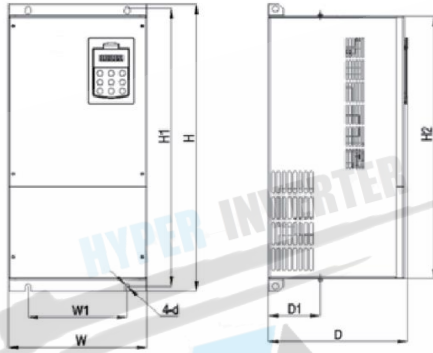

DSI-400-110G3/132P3~DSI-400-315G3/355P3 class

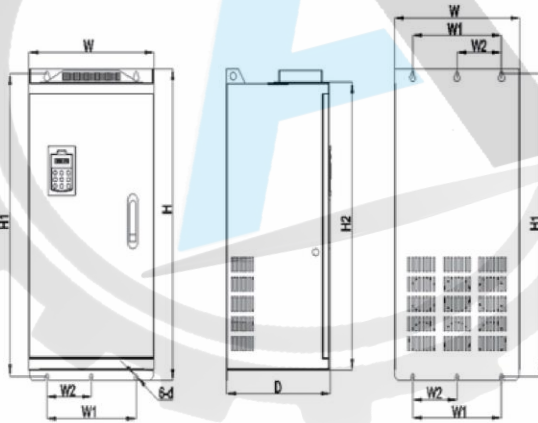

DSI-400-355G3/400P3~DSI-400-500G3 class

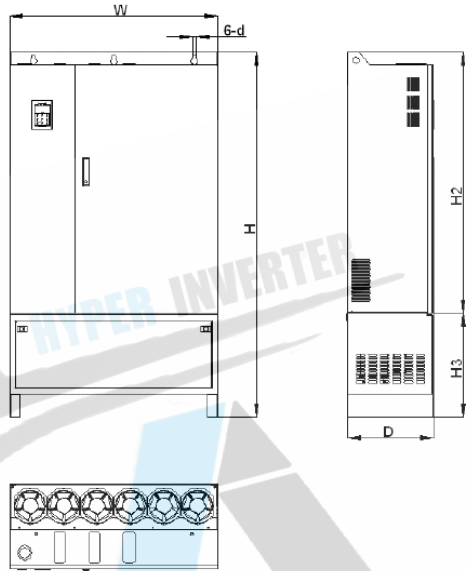

Fig.1-4 Product outline and mounting dimension

Shape DIM	Shape dimension (mm)			Installation dimension (mm)				note
	W	H	D	W1	H1	D1	Asse mby	
DSI-400-K40G1	118	185	164	106	175	156	M4	
DSI-400-K75G1								
DSI-400-1K5G1								
DSI-400-2K2G1								
DSI-400-K75G3								
DSI-400-1K5G3								
DSI-400-2K2G3								
DSI-400-004G3								
DSI-400-5K5G3								
DSI-400-7K5G3/011P3	160	247	190	148	235	182	M5	
DSI-400-011G3/015P3								
DSI-400-015G3/018P3	220	320	210	205	306	202	M5	
DSI-400-018G3/022P3								
DSI-400-022G3/030P3								
DSI-400-030G3/037P3	250	400	244	230	380	232	M7	
DSI-400-037G3/045P3								
DSI-400-045G3/055P3	280	583	290	200	562	150	M10	
DSI-400-055G3/75P3								
DSI-400-075G3/90P3	300	688	340	200	667	—	M10	
DSI-400-090G3/110P3								

Section I. Product Information

DSI-400-110G3/132P3	420	840	350	300	815	—	M11	
DSI-400-132G3/160P3								
DSI-400-160G3/185P3								
DSI-400-185G3/200P3	640	1035	395	500	100	—	M13	
DSI-400-200G3/220P3								
DSI-400-220G3/250P3								
DSI-400-250G3/280P3								
DSI-400-280G3/315P3								
DSI-400-315G3/355P3								
DSI-400-355G3/400P3	960	1240	400	740	120	—	M14	
DSI-400-400G3/450P3								
DSI-400-450G3								
DSI-400-500G3								

1.5 Standard specification

Item		Specifications	
Basic function	Control system	High performance of current vector control technology to realize asynchronous motor and synchronous motor control	
	Drive performance	High efficiency driving for induction motor and synchronous motor	
	Maximum frequency	Vector control: 0~500Hz; V/F control: 0~3200Hz	
	Carrier frequency	0.5k~16kHz;the carrier frequency will be automatically adjusted according to the load characteristics	
	Input frequency resolution	Digital setting: 0.01Hz Analog setting: maximum frequency x0.025%	
	Control mode	Open loop vector control(SVC) Closed loop vector control(FVC) V/F control	
	Startup torque	Type G: 0.5Hz/150%(SVC): 0Hz/180%(FVC)	
	Speed range	1: 100(SVC)	Speed range
	Speed stabilizing precision	±0.5%(SVC)	Speed stabilizing precision
	Torque control precision	±5%(FVC)	
	Over load capability	G type: rated current 150% -1 minute, rated current 180% -3 seconds;	
	Torque boost	Auto torque boost function: Manual torque boost 0.1%~30.0%	
	V/Fcurve	Linear V/F, Multi-point V/F and Square V/F curve (power of 1.2, 1.4, 1.6, 1.8, 2)	
	V/F separation	In 2 ways: separation ,semi separation	
	Acc. /dec curve	Straight line or S curve acceleration and deceleration mode. Four kinds of acceleration and deceleration time. Acceleration and deceleration time range between 0.0s to 6500.0s	
	DC brake	DC brake frequency: 0.00Hz to maximum frequency,brake time: 0.0s to 36.0s, and brake current value: 0.0% to 100.0%.	
	Jog control	Jog frequency range: 0.00Hz~50.00Hz. Jog acceleration/deceleration time 0.0s~6500.0s.	

Section I. Product Information

	Simple PLC and MS speed running	It can realize at maximum of 16 segments speed running via the built-in PLC or control terminal.
	Built-in PID	It is easy to realize process-controlled close loop control system
	Auto voltage regulation (AVR)	It can keep constant output voltage automatically in case of change of network voltage.
	Over-voltage/current stall control	It can limit the running voltage/current automatically and prevent frequent over-voltage/current tripping during the running process
	Quick current limit	Minimize the over-current fault,protect normal operation of the inverter
	Torque limit & control	"Excavators" characteristics,automatically limit torque during operation,prevent frequent over-current trip; Closed loop vector mode can realize the torque control.
Personalized	Instantaneous stop non-stop	When instantaneous power off,voltage reduction is compensated through load feedback energy,which could make inverter keep running in a short period of time.
	Rapid current limit	To avoid inverter frequent over-current fault.
	Virtual IO	5 groups of virtual DI,DO to realize simple logic control
	Timing control	Timing control function: settimerange0Min~6500.0Min
	Multiple motor switch	4 groups of motor parameter,which can realize 4-motor switch control
	Multi-threaded bus support	Standard MODBUS: RS485
	Multi-encoder support	Support difference,open collector, UVW, rotary transformer, sine cosine encoder etc.
Running	Running command channel	Three types of channels: operation panel reference,control terminal reference and serial communication port reference.These channel scan be switched in various modes.
	Frequency source	There are totally eleven types of frequency sources, such as digital reference, analog voltage reference, analog current reference, pulse reference, MS speed, PLC, PID and serial port reference.
	Auxiliary frequency source	11 kinds of auxiliary frequency source which can flexible achieve auxiliary frequency tuning, frequency synthesis
	Input terminal	Standard: There are 7 digital input terminals,DI5 can be used as100kHz high-speed input pulse. 2 analog input terminals which can be used as 0-10V voltage input or

Section I. Product Information

		0~20mA current input.
	Output terminal	Standard: 2 digital output terminals, FM is high-speed pulse output terminal (can be chosen as open circuit collector type), support 0~100kHz square wave signal; 2 relay output terminal; 2 analog output terminals, support 0~20mA output current or 0~10V output voltage;
Keyboard operation	LED display	Realize parameter setting,status monitoring function
	Keyboard potentiometer	Equipped with keyboard potentiometer or coding potentiometer
	Key lock&function selection	Realize button locking,define operation range for part of buttons to prevent operation fault.
	Protection function	It can implement power-on motor short-circuit detection,input/output phase loss protection, over current protection,over voltage protection,under voltage protection,overheating protection and overload protection.
	Optional parts	Differential input PG card, UVW differential input PG card, rotating inverter PG card, OC input PG card.
Environment	Using place	Indoor,and be free from direct sunlight,dust,corrosive gas, combustible gas,oil smoke, vapor,drip salt.
	Altitude	Below 1000m
	Ambient temperature	-10 ℃ to +40 ℃ (Derating use when under ambient temperature of 40 ℃ to 50 ℃)
	Humidity	Less than 95%RH, without condensing
	Vibration	Less than 5.9 m/s ² (0.6g)
	Storage temperature	-20℃~+60℃

Table: 1-5.1

Section II. Installation & Wiring

2.1 Use of the environment

- 1) Ambient temperature-10°C~40°C.
- 2) Avoid electromagnetic interference and keep the unit away from the source of interference.
- 3) Prevent dropping water, steam, dust powder, cotton fiber or fine metal powder from invasion.
- 4) Prevent oil, salt and corrosive gas from entering it.
- 5) Avoid vibration. Vibration should be less than 0.6G. Keep away from punching machine etc.
- 6) Avoid high temperature, moisture or being wet due to raining, with the humidity below 95%RH (non-condensing).
- 7) Prohibit the use in the dangerous environment where inflammable or combustible or explosive gas, liquid or solid exists.

2.2 Handling and installation

- ※ When transporting inverter, right lifting tools are required to prevent inverter from damaging.
- ※ The number of stacked box of the inverter are not permitted higher than the limit.
- ※ Please don't run the inverter if there is damage or lacking of components.
- ※ Do not place heavy objects on the frequency inverter.
- ※ Please prevent screw, cable pieces or other conductive objects or oil etc inflammable objects invading the frequency inverter.
- ※ Do not make it fall or have a strong impact.
- ※ Confirm if the installation location and object could withstand the weight of the inverter. The frequency inverter must be installed by wall hooking、 indoor room with adequate ventilation, with enough space left between it and the adjacent objects or retaining board (walls) around, as shown in the picture below:

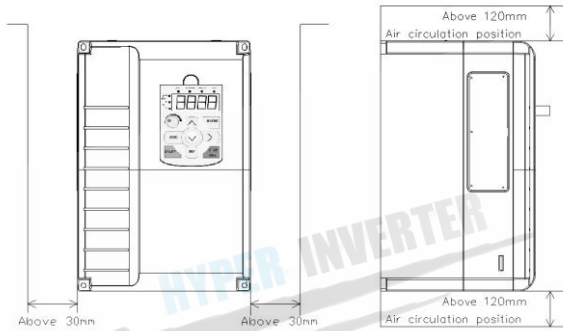

Fig. 2-2.1

Heat dissipation problems should be concerned when doing mechanical installation, please mind rules belows:

- 1) Mounting space is shown in 2-2.1, which could ensure the heat sinking space of the inverter. However, the heat sinking of other devices in the cabinet shall also be considered.
- 2) Install the inverter vertically so that the heat may be expelled from the top. However, the equipment cannot be installed upside down. If there are multiple inverters in the cabinet, parallel installation is better. In the applications where up-down installation is required, please install the thermal insulating guide plate referring to the Fig. 2-2.2 for standalone installation and up-down installation.
- 3) Installing support must be flame retardant materials.
- 4) It is suggested that cooling cabinet be put outside at places where powder dust exists. Space inside the sealed cabinet shall be large as much as possible.

2.4 Wiring

The wiring of frequency inverter includes two parts: main circuit and control circuit. Users must ensure correct connections according to the following connection diagram.

2.4.1 DSI-400 diagram

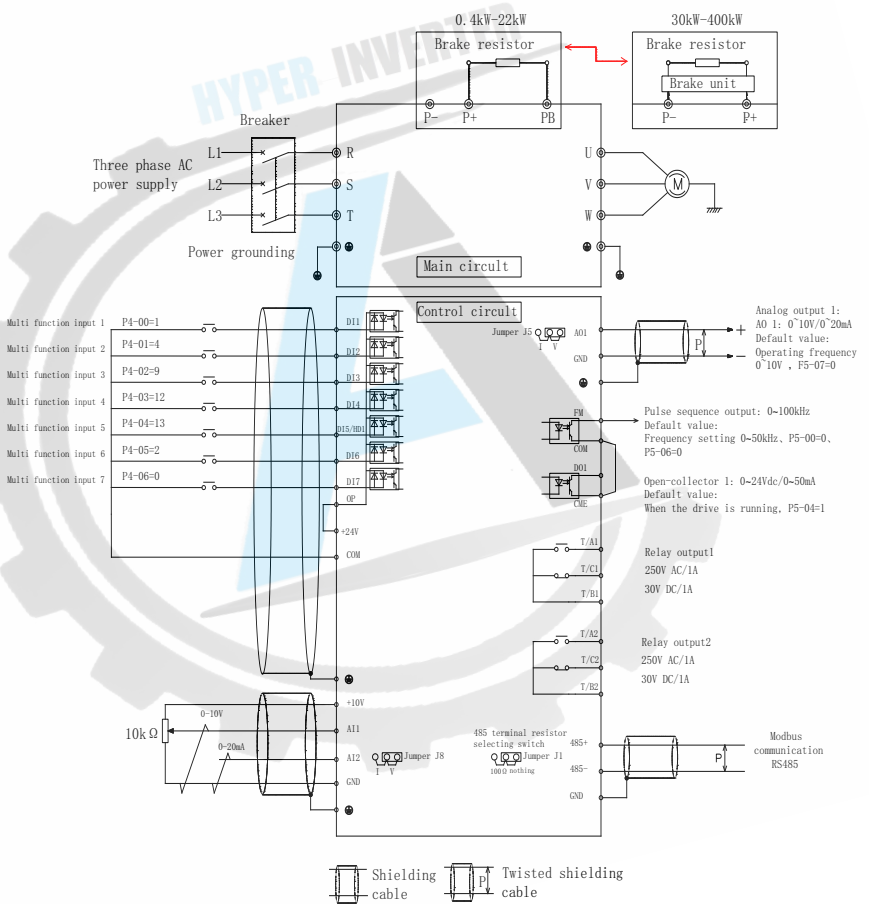

Fig. 2-4.1

2.5 Main circuit terminals (G type)

2.5.1 DSI-400 main circuit terminals

Terminal Name	Function description
R、S、T	Three phase power input terminal
P+、PB	External Break resistor reserved terminal(0.4KW~22KW)
U、V、W	Three phase AC output terminal
PE	Earth terminal

2.5.2 Caution of Main Circuit wiring

1) Input Power R、S、T :

- AC Drive input side connection, no phase sequence requirements.

The specifications and installation methods of the external power wiring should comply with the local regulations and related IEC standards.

Please refer to the following table for power cable wiring :

2.6 Control circuit terminals

2.6.1 Control circuit terminal arrangement

DSI-400 Control circuit terminals

485	485-	GND	DI1	DI2	DI3	DI4	DI5	DI6	DI7	COM
+10V	AI1	AI2	GND	AO1	DO1	FM	CME	COM	OP	+24V

T/A1	T/B1	T/C1
T/A2	T/B2	T/C2

2.6.2 Control circuit terminals description

Terminals function description:

Type	Terminal sign	Terminal Name	FunctionDescription
Power supply	+10V-GND	External terminal of 10V power supply	Provide +10V power supply for external units, with maximum output current of 10mA. It is generally used as the operating power supply for the external potentiometer. The potentiometer resistance range is 1kΩ to 5kΩ.
	+24V-COM	External terminal of 24V power supply	Provide +24V power supply for external units. It is generally used as the operating power supply for digital input/output terminal and the external sensor. Maximum output current: 200mA
	OP	External power input terminals	When using external signal to drive DI1~DI7, OP should be connected to external power supply, connection with +24V(J9) as factory default.
Analog input	A11-GND	Analog input terminal 1	Input voltage range: DC 0V to 10V
	A12-GND	Analog input terminal 2	1. Input range: DC 0V~10V/4mA~20mA, chosen by jumper J8 on control board 2. Input impedance : 22kΩ of voltage input, 500Ω of current input.
Digital Input	DI1-OP	Digital Input 1	1. Optical coupling isolation, bipolar input. 2. Input impedance: 4.7kΩ. 3. Electrical level input range: 9V~30V.
	DI2-OP	Digital Input 2	
	DI3-OP	Digital Input 3	
	DI4-OP	Digital Input 4	

	DI5-OP	Digital Input 5	1. Input impedance: 2.4 kΩ.
	DI6-OP	Digital Input 6	Same as DI1
	DI7-OP	Digital Input 7	Same as DI1
	HDI DI5-OP	High-speed pulse input terminal	DI5 can be used as high-speed pulse input channel. Maximum input frequency: 100kHz.
Analog output	AO1-GND	Analog output 1	The voltage or current output is determined by jumper J5 on the control panel. Output voltage range: 0V to 10V Output current range: 0mA to 20mA.
Digital Output	DO1-CME	Digital output 1	Optical coupling isolation, dual polarity open collector output. Output voltage range: 0V to 24V Output current range: 0mA to 50mA
	FM-CME	High-speed pulse output	High-speed pulse output, maximum frequency can reach 100kHz. Function code P5.00 as constraints. As open collector output, the function is same as DO1.
Relay output1	TA1-TB1	Normally closed	Contact driving capacity: AC250V, 3A, COSφ=0.4
	TA1-TC1	Normally open	
Relay output2	TA2-TB2	Normally closed	Contact driving capacity: AC250V, 3A, COSφ=0.4
	TA2-TC2	Normally open	
communication	485+ 485-	MODBUS	MODBUS port, non isolation

2.6.3 Description of wiring of control terminals

1) Analog input terminal

Because the weak analog signal will be easily affected by the external interference, generally shielded cable shall be used, the cable length shall be as short as possible and no longer than 20 meters, as shown in Fig. 2-6.1. In case the analog signal is subject to severe interference, analog signal source side shall be installed with filter capacitor or ferrite magnetic ring, as shown in Fig.2-6.2.

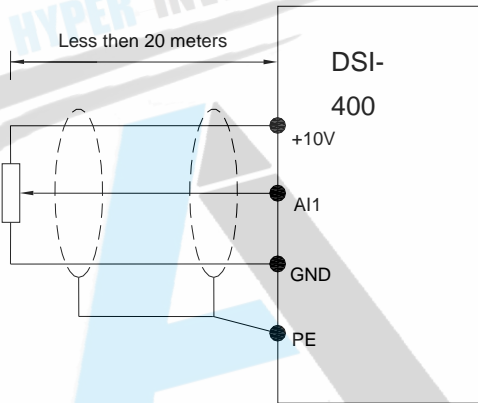

Fig. 2-6.1 Analog input terminal wiring diagram

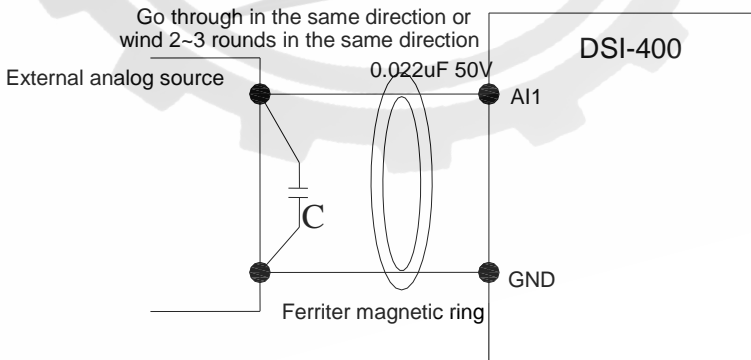

Fig.2-6.2 Analog input terminal processing wiring diagram

2) Digital input terminal

It needs to employ shielded cable generally, with wiring distance of no longer than 20 meters. When valid driving is adopted, necessary filtering measures shall be taken to prevent the interference to the power supply.

It is recommended to use the contact control mode.

a) DI terminal wiring method (The drain wiring mode)

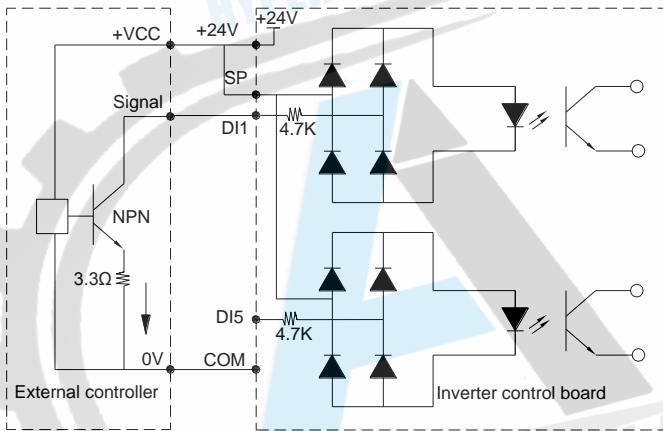

Fig.2-6.3 Drain wiring mode

This is one of the most commonly used connection mode. If you use an external power supply, J9 jumper must be removed, and connect the external positive power supply to OP, while negative power supply to DI port.

b) DI terminal wiring method (The source wiring mode)

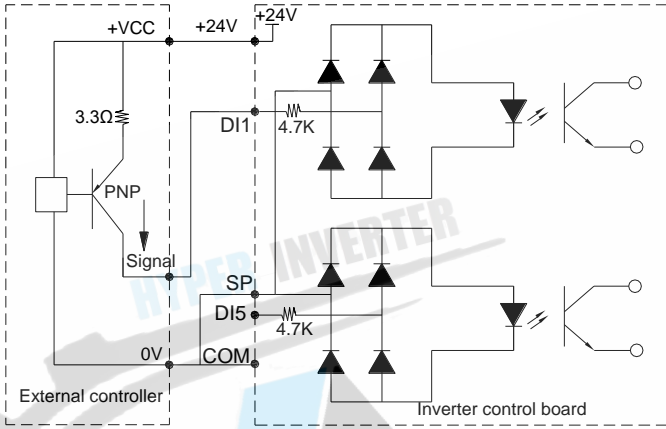

Fig. 2-6.4 Source wiring mode

This connection mode must make OP of jumper J9 connect to COM port, and connect +24V and public terminal of external controller together. If you use an external power supply, jumper J9 must be removed, and connect external negative power supply to OP, while positive power supply to DI port.

2) Digital output terminal

When drive relay is essential for digital output terminal, you should add absorption diode to both sides of relay coil. Or +24V dc power supply will be easily damaged.

Caution: The polarity of the absorption diode must be installed correctly according to the picture below. Or +24V dc power supply will immediately get burnt after digital output terminal outputs.

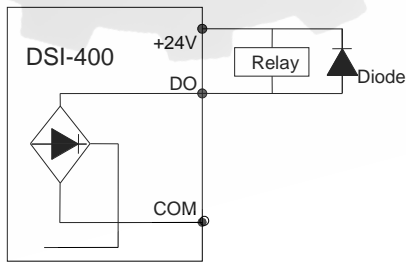

Fig. 2-6.5 Digital output terminal wiring diagram

2.7 Standby circuit

Inverter fault or jump may cause great breakdown loss or other accident. To avoid this happens, please add the standby circuit below to ensure security.

Note: Confirm and test the running characteristic of the standby circuit, make sure that the industrial phase and the converter phase are in the same direction.

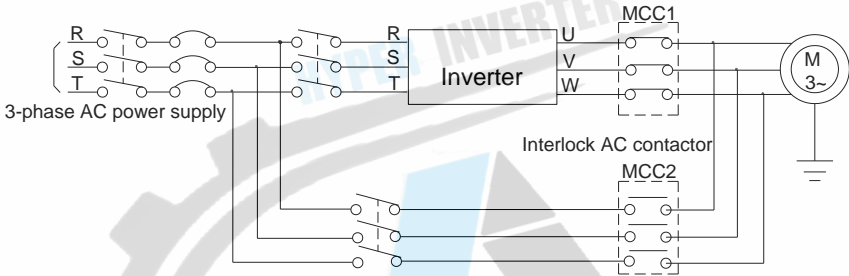

Fig. 2-7.1

Section III. Fittings

3.1 Connection with peripheral devices

3.1.1 Connection of the Product and Peripheral Devices

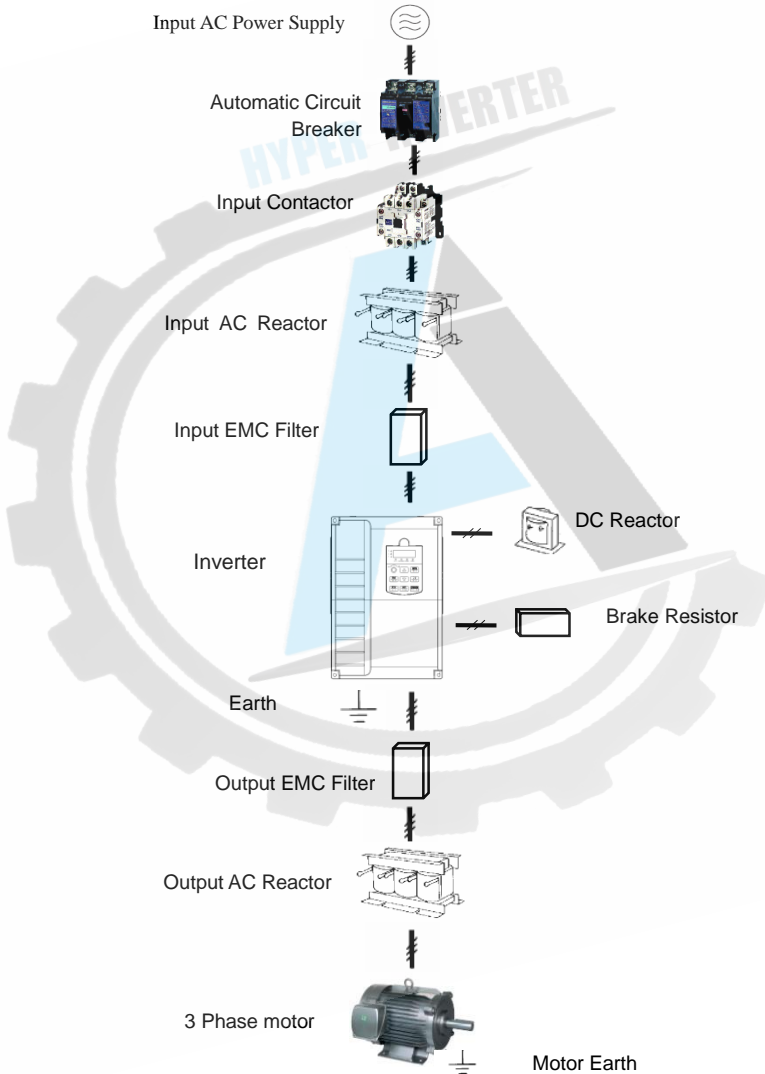

Fig.3-1 Connection diagram of the product and peripheral devices

3.1.2 Peripheral Electric Parts of DSI-400

Part Name	Installation Location	Function Description
Circuit breaker	The front-end of the input circuit	Disconnect the power supply in case of downstream equipment is over current
Contactora	Between the circuit breaker and the inverter input side	Power-on and power-off of the inverter.Frequent power-on/power-off operation(at least once per minute) on the inverter should be avoided
AC input reactor	Input side of the inverter	<p>Improve the power factor of the input side:</p> <ol style="list-style-type: none"> 1.Eliminate the high order harmonics of the input side effectively, and prevent other equipment from damaging due to voltage waveform deformation. 2.Eliminate the unbalanced input current due to the unbalanced power phases.
EMC input filter	Input side of the inverter	<ol style="list-style-type: none"> 1.Reduce the external conduction and radiation interference of the inverter; 2.Reduce the conduction interference flowing from the power end to the inverter, thus improving the anti-interference capacity of the inverter. 3.The common size of 3-phase EMI noise filter is shown as following: confirm the power supply is 3-phase three lines or 3-phase four lines or single phase. Grounding wire is as short as possible, try to place the filter near the converter. <p>Please choose EMI filter when the inverter is used in residential area, commercial area, science area as well as situations where higher demand to prevent radio interference is needed or meeting CE、UL、CSA standard but existing equipment that anti-interference ability is not sufficient.</p> <p>If needing the filter, please connect with the company.</p>
DC reactor	DSI-400 series can adopt external DC reactor according to the need.	<p>Improve the power factor of the input side:</p> <ol style="list-style-type: none"> 1.Improve the overall efficiency and thermal stability 2.Effectively reduce the influence of high order

Section IV. Keyboard Operation

		<p>harmonics at the input side on the inverter and reduce the external conduction and radiation interference.</p>
AC output reactor	<p>Between the inverter output side and the motor, close to the inverter</p>	<p>The inverter output side generally has higher harmonic. When the motor is far from the inverter, since there are many capacitors in the circuit, certain harmonics will cause resonance in the circuit and bring in the following results:</p> <ol style="list-style-type: none"> 1. Degrade the motor insulation performance and damage the motor for the long run 2. Generate large leakage current and cause frequent inverter protection action 3. In general, if the distance between the inverter and the motor exceeds 100 meters, output AC reactor should be installed
Output EMI filter	<p>Between the inverter output side and the motor, close to the inverter</p>	<p>The fittings can restrain the disturbance noise and lead line leak current produced in the output side.</p>

Table: 3-1.1

3.2 Mounting hole dimension

3.2.1 Braking unit & Braking resistance

When customers choose the type with braking, there will be braking unit inside the inverter, maximum braking torque is 50%. Please refer to the table below and choose the matched braking resistance separately.

Shape DIM	Braking unit	Braking unit		Braking moment %
		Braking	Quantity	
DSI-400-K40G1	Standard built-in	100W 300Ω	1	220
DSI-400-K75G1		120W 200Ω	1	125
DSI-400-1K5G1		300W 100Ω	1	125
DSI-400-2K2G1		300W 70Ω	1	120
DSI-400-K75G3		100W 300Ω	1	130
DSI-400-1K5G3		200W 300Ω	1	125
DSI-400-2K2G3		200W 200Ω	1	135
DSI-400-3K7G3		400W 150Ω	1	135
DSI-400-5K5G3		500W 100Ω	1	135
DSI-400-7K5G3		800W 75Ω	1	130
DSI-400-011G3		1040W 50Ω	1	135
DSI-400-015G3		1560W 40Ω	1	125
DSI-400-018G3		4800W 32Ω	1	125
DSI-400-022G3		4800W 27.2Ω	1	125
DSI-400-030G3		outlay	6000W 20Ω	1
DSI-400-037G3	9600W 16Ω		1	125
DSI-400-045G3	9600W 13.6Ω		1	125
DSI-400-055G3	6000W 20Ω		2	135
DSI-400-075G3	9600W 13.6Ω		2	145

Table: 3-2.1

If you need accessories in the table, please declare in order.

For larger built-in braking torque, please use the HNC braking unit. You can refer to HNC braking unit manual for details.

Other large power models do not contain a built-in braking. If large power model need to be equipped with braking function, please choose HNC braking unit.

External DC reactor installation:

For DSI-400 series inverter, external DC reactor can be ordered according to your needs. When installation, you should tear down copper platoon between DC+1 and DC+2 of inverter main circuit. And then add reactor between DC+1 and DC+2, wiring between reactor terminals and inverter terminals DC+1 and DC+2 have no polarity. After installation of DC reactor, short circuit copper platoon between DC+1 and DC+2 is no more used.

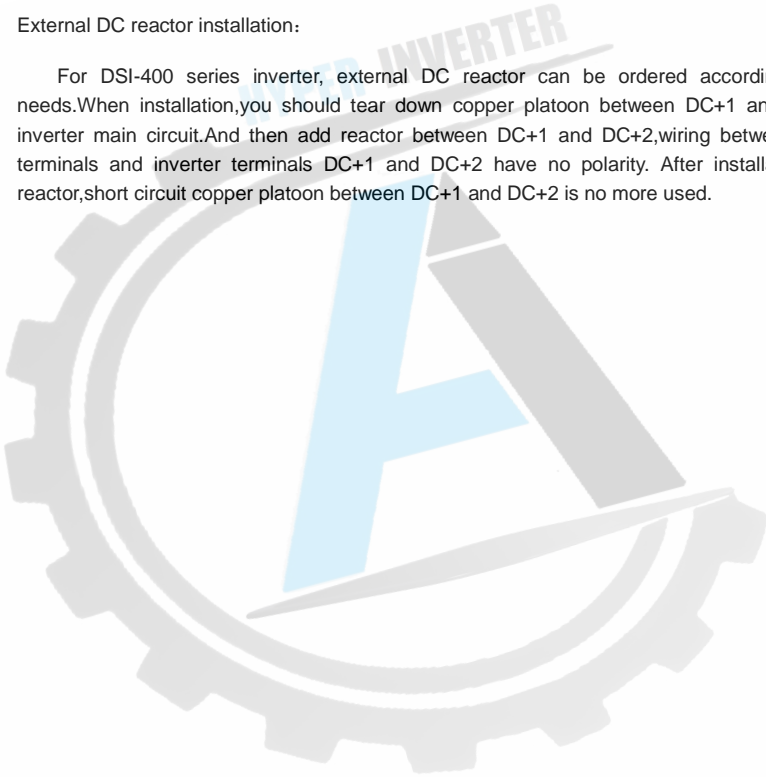

3.2.2 Specifications of circuit breaker、cable and contactors

Shape DIM	breaker (A)	contactor (A)	R、S、T、 Φ 、B、 Θ 、U、V、W			Terminal screwPE \oplus		
			Terminal screw	Fastening Moment (N·m)	Wire standard (mm ²)	Terminal screw	Fastening Moment (N·m)	Wire standard (mm ²)
DSI-400-K40G1	16	10	M4	1.2~1.5	2.5	M4	1.2~1.5	2.5
DSI-400-K75G1	25	16	M4	1.2~1.5	2.5	M4	1.2~1.5	2.5
DSI-400-1K5G1	32	25	M4	1.2~1.5	4	M4	1.2~1.5	2.5
DSI-400-2K2G1	40	32	M4	1.2~1.5	6	M4	1.2~1.5	4
DSI-400-K75G3	10	10	M4	1.2~1.5	2.5	M4	1.2~1.5	2.5
DSI-400-1K5G3	16	10	M4	1.2~1.5	2.5	M4	1.2~1.5	2.5
DSI-400-2K2G3	16	10	M4	1.2~1.5	2.5	M4	1.2~1.5	2.5
DSI-400-3K7G3	25	16	M4	1.2~1.5	4	M4	1.2~1.5	4
DSI-400-5K5G3	32	25	M4	1.2~1.5	6	M4	1.2~1.5	6
DSI-400-7K5G3	40	32	M4	1.2~1.5	6	M4	1.2~1.5	6
DSI-400-011G3	63	40	M5	2.5~3.0	6	M5	2.5~3.0	6
DSI-400-015G3	63	63	M5	2.5~3.0	6	M5	2.5~3.0	6
DSI-400-018G3	100	63	M6	4.0~5.0	10	M6	4.0~5.0	10
DSI-400-022G3	100	100	M6	4.0~5.0	16	M6	4.0~5.0	16
DSI-400-030G3	125	100	M6	4.0~5.0	25	M6	4.0~5.0	16
DSI-400-037G3	160	100	M8	9.0~10.0	25	M8	9.0~10.0	16
DSI-400-045G3	200	125	M8	9.0~10.0	35	M8	9.0~10.0	16
DSI-400-055G3	315	250	M10	17.6~22.5	50	M10	14.0~15.0	25
DSI-400-075G3	350	330	M10	17.6~22.5	60	M10	14.0~15.0	35
DSI-400-090G3	315	250	M10	17.6~22.5	70	M10	14.0~15.0	35
DSI-400-110G3	350	330	M10	17.6~22.5	100	M10	14.0~15.0	50
DSI-400-132G3	400	330	M12	31.4~39.2	150	M12	17.6~22.5	75
DSI-400-160G3	500	400	M12	31.4~39.2	185	M12	17.6~22.5	50×2
DSI-400-200G3	630	500	M12	48.6~59.4	240	M12	31.4~39.2	60×2
DSI-400-220G3	800	630	M12	48.6~59.4	150×2	M12	31.4~39.2	75×2
DSI-400-280G3	1000	630	M12	48.6~59.4	185×2	M12	31.4~39.2	100×2
DSI-400-315G3	1000	800	M14	48.6~59.4	250×2	M14	31.4~39.2	125×2
DSI-400-355G3	1200	800	M14	48.6~59.4	325×2	M14	31.4~39.2	150×2
DSI-400-400G3	1500	1000	M14	48.6~59.4	325×2	M14	31.4~39.2	150×2

Table: 3-2.3

Section IV. Keyboard Operation

4.1 Keyboard size

4.1.1 DSI-400 keyboard specification

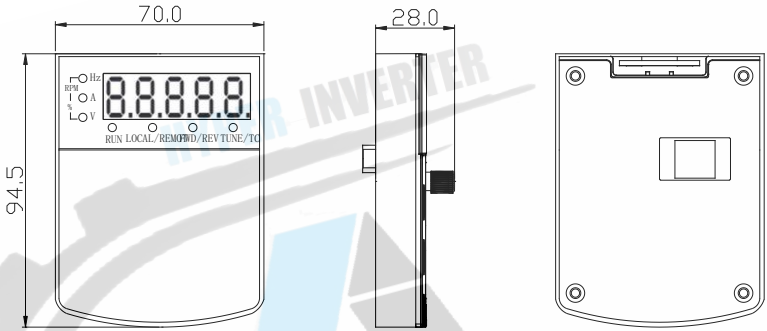

Fig. 4-1.1

4.1.2 Keyboard warehouse JP3 dimension

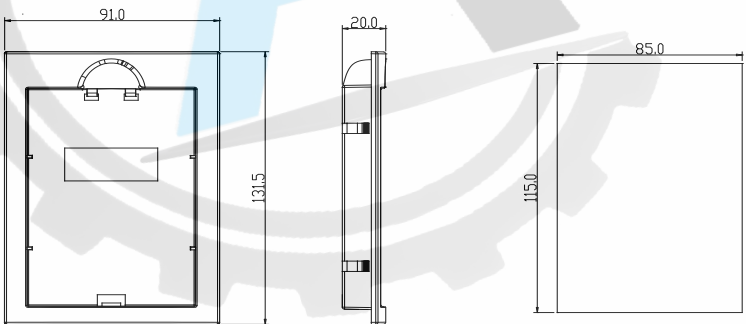

Fig. 4-1.2

4.2 Display Interface

Modification of function parameter, monitoring of inverter operation, control of inverter operation (start and stop) can be performed through the operation panel. Its shape and function area are shown as below:



Fig. 4-2.1

4.2.1 Function description of operation panel

Keyboard Parameter	Description
FWD/REV	Forward/Reserved Running Light *ON: forward running *OFF: Reserved running
RUN	Running indicator *ON: running state *OFF: stop state
LOCAL/REMOT	Command source indicator keyboard operation, terminal operation and remote operation(communication control) indicator *ON: terminal operation control state *OFF: keyboard operation control state *Flashing: remote operation control state

Section IV. Keyboard Operation

TUNE/TC	<p>Tuning/Fault indicator</p> <p>*ON: torque control mode</p> <p>*Slow flashing: tuning state</p> <p>*Quick flashing: fault state</p>
<p>Hz A V</p> <p>RPM(Hz+A)</p> <p>%(A+V)</p>	<p>Unit indicator</p> <p>* Hz frequency unit</p> <p>*A current unit</p> <p>*V voltage unit</p> <p>*RMP(Hz+A)revolving speed unit</p> <p>*%(A+V)percentage</p>
Digital display	<p>Digital display area</p> <p>*5-bit LED display,monitor set frequency,output frequency,various monitoring data,alarm code etc.</p>
PRG+>/SHIFT=QUICK	<p>Menu mode selection code,shift different menu mode according to the value of PP.03 (Function parameter mode as default)</p>
PRG	<p>Programming key</p> <p>*Primary menu enter or exit</p>
>/SHIFT	<p>Shift key</p> <p>*On the stop display interface or running display interface, it can be used to circularly select the display parameters. When modifying the parameters, it can be used to select the bits of parameter for modification</p>
ENTER	<p>Confirmation key</p> <p>*Gradually step into the menu screen,set parameters confirmation</p>
∧	<p>Increase key</p> <p>*Increase of the data or function code</p>
∨	<p>Decrease key</p> <p>*Decrease of the data or function code</p>
MF/REV	<p>Multi-function selection key</p> <p>*It is used as functions witching selection according to P7-01.</p>

Section IV. Keyboard Operation

Potentiometer	Potentiometer * P0.03 is set to 4 as default;
RUN	Running key * It is used to start the running of the inverter under keyboard control mode
STOP/RESET	Stop/reset * In running status,it can stop the running by pressing this key. In alarm status,it can reset operation with this key. The characteristics of this key are limited by function code P7.02.

Table 4-2.1



4.3 Examples for parameter setting

4.3.1 Description of function code viewing and modification method

The operation panel of DSI-400 inverter adopts three-level menu structure to perform parameter setting. The three-level menu includes: function parameter group (level 1 menu) → function code (level 2 menu) → setting value of function code (level 3 menu). The operation process is as shown in Figure below.

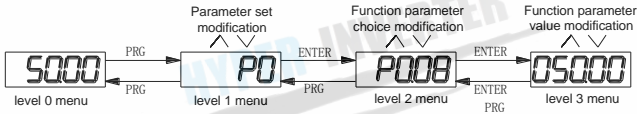

Table 4-3.1

Caution: When operating on level 3 menu, press PRG key or ENTER key to return to level 2 menu. The difference between ENTER and PRG keys is that pressing ENTER KEY will save the setup parameter and return to level 2 menu and then automatically shift to the next function code, while pressing PRG key will directly return to level 2 menu without saving the parameter, and it will return to the current function code.

Take the modification of function code P3.02 (ranging from 10.00Hz to 15.00Hz) as an example. (The boldface bit indicates the flashing bit).

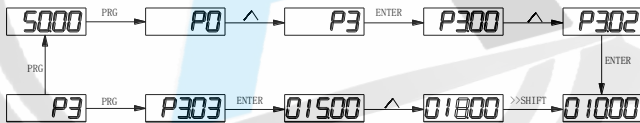

Table 4-3.2

In level 3 menu, if the parameter has no flashing bit, it indicates that the function code cannot be modified. The possible reasons include:

- 1) The function code is an unchangeable parameter, such as actual detection parameter, running record parameter, etc.
- 2) The function code cannot be modified in running status but can be modified after the unit is stopped.

4.3.2 Parameter display mode

Parameter display mode is mainly established to view different arrangement forms of function parameters according to user's actual needs. 3 kinds of display mode:

Name	Description

Function parameter mode	Sequence display inverter function parameters ,there are P0~PF、A0~AF、U0~UF function groups respectively.
User set parameter mode	User set individual function parameters(32 at most), parameters that needed to be displayed can be set through PE group
User modify parameter mode	Inconsistent with factory default parameters

Table 4-3.1



Relevant function parameters PP.02、PP.03, set as below:

PP.02	Parameters display mode attributes		Default value	11
	Set range	1bit	U group display selection	
		0	No display	
		1	Display	
		10bit	A group display selection	
		0	No display	
1		Display		
PP.03	Individual parameter mode display selection		Default value	00
	Set range	1bit	User set parameter display selection	
		0	No display	
		1	Display	
		10bit	User modify parameter display selection	
		0	No display	
1		Display		

Table 4-3.2

When there is 1bit display existing in the individual parameter mode display selection(PP.03), you can enter different parameter display mode by pressing PRG+>>/SHIFT key at the same time.

Each parameter display codes:

Parameter display mode	Display
Function parameter mode-FunC	-FunC
User set parameter mode -USEt	-USEt
User modify parameter mode -U--C	-U--C

Table 4-3.3

Switching mode as below:

E.g: To switch current function parameter mode to user set parameter mode.



Fig. 4-3.3

4.3.3 User set parameter operation mode

User set menu is established for quick checkup and modification. The display mode is “uP3.02”, which represents function parameter P3.02. It has the same effect of modifying parameter in user set menu and normal programming state.

Function parameters of user set menu come from PE group. PE group chooses function parameter: when PE is set to P0.00, it means no choosing, totally 30 functions can be set. If display “NULL” when entering menu, it means user set menu is null.

16 parameters have been stored at initial time for user's convenience:

P0.01: Control mode	P0.02: Command source selection
P0.03: Main frequency source selection	P0.07: Frequency source selection
P0.08: Preset frequency	P0.17: Acceleration time
P0.18: Deceleration time	P3.00: V/F curve set
P3.01: Torque boost	P4.00: DI1 Terminal function selection
P4.01: DI2 terminal function selection	P4.02: DI3 terminal function selection
P5.04: DO1 output selection	P5.07: AO1 output selection
P6.00: Startup mode	P6.10: Stop mode

Users could modify the user set parameter according to specific need of your own.

4.3.4 Check method of state parameter

When the inverter is in stop or running status, multiple status parameters can be displayed. It can select if this parameter is to be displayed in binary bit with the function codes P7.03 (running parameter1), P7.04 (running parameter2) and P7.05 (stop parameter).

In stop status, there are 4 running state parameter: set frequency, bus voltage, analog input voltage AI1, analog input voltage AI2 which of them are of default display. Other display parameters respectively: DI input state, DO output state, analog input voltage AI3, actual count value, actual length value, PLC running steps, load speed display, PID set, PULSE input pulse frequency and 3 reserved parameters (whether to display or not is determined by function code P7.05 binary bit choice). Selected parameter are switched in sequence order.

In running status, there are a total of 5 running status parameters, including: setup frequency, running frequency, bus voltage, output voltage, output current, which of them are of default display. Other display parameters respectively: output power, output torque, DI input state, DO output state, analog input voltage AI1, analog input voltage AI2, analog input voltage AI3, actual count value, actual length value, linear velocity, PID set, PID feedback etc. Whether to display or not is determined by function code P7.03, P7.04 binary bit choice. Selected parameter are switched in

sequence order.

When inverter power on after powered off , the display parameter is the one that chosen before power off as default.

4.3.5 Password Setting

The inverter provides user password protection function. When PP.00 is set to non-zero value, it is user password and enabled after exiting the function code editing status. When the user presses the PRG key again, “----“will be displayed to require the user to enter user password, or the user cannot enter the general menu.

To cancel the password protection function, the user needs to enter the relevant interface through password, and change the PP.00 setting to 0.

4.3.6 Motor parameter automatic tuning

Vector control running mode: before running, user must accurately input motor nameplate parameters. DSI-400 series inverter will be matching standard motor parameter according to this nameplate. Vector control methods are very much dependent on motor parameters, to get good control performance, accurate control motor parameters must be acquired.

Motor parameter auto tuning procedure is as follows:

Firstly, select command source(P0.02) as operation panel command channel. Secondly, input parameters below in accordance with motor actual parameter:

Motor selection	Parameter	
Motor 1	P1.00 : Motor type selection	P1.01 : Motor rated power
	P1.02 : Motor rated voltage	P1.03 : Motor rated current
	P1.04 : Motor rated frequency	P1.05 : Motor rated revolving speed
Motor 2	A2.00 : Motor type selection	A2.01 : Motor rated power
	A2.02 : Motor rated voltage	A2.03 : Motor rated current
	A2.04 : Motor rated frequency	A2.05 : Motor rated revolving speed
Motor 3	A3.00 : Motor type selection	A3.01 : Motor rated power
	A3.02 : Motor rated voltage	A3.03 : Motor rated current

	A3.04 : Motor rated frequency	A3.05 : Motor rated revolving speed
Motor 4	A4.00 : Motor type selection	A4.01 : Motor rated power
	A4.02 : Motor rated voltage	A4.03 : Motor rated current
	A4.04 : Motor rated frequency	A4.05 : Motor rated revolving speed

Table 4-3.4

E.g: Asynchronous motor parameter tuning

If motor and the load can be totally separated, please select P1.37(Motor 2\3\4 as A2\A3\A4.37) to 2(Asynchronous machine complete tuning), then press RUN key on keyboard panel, inverter will automatically calculate the motor of the following parameters:

Motor selection	Parameter
Motor 1	P1.06 : Asynchronous motor stator resistance
	P1.07 : Asynchronous motor rotor resistance
	P1.08 : Asynchronous motor leakage inductance
	P1.09 : Asynchronous motor mutual inductance
	P1.10 : Asynchronous motor no-load current
Motor 2	A2.06 : Asynchronous motor stator resistance
	A2.07 : Asynchronous motor rotor resistance
	A2.08 : Asynchronous motor leakage inductance
	A2.09 : Asynchronous motor mutual inductance
	P2.10 : Asynchronous motor no-load current
Motor 3	A3.06 : Asynchronous motor stator resistance

	<p>A3.07 : Asynchronous motor rotor resistance</p> <p>A3.08 : Asynchronous motor leakage inductance</p> <p>A3.09 : Asynchronous motor mutual inductance</p> <p>P3.10 : Asynchronous motor no-load current</p>
Motor 4	<p>A4.06 : Asynchronous motor stator resistance</p> <p>A4.07 : Asynchronous motor rotor resistance</p> <p>A4.08 : Asynchronous motor leakage inductance</p> <p>A4.09 : Asynchronous motor mutual inductance</p> <p>P4.10 : Asynchronous motor no-load current</p>

Table4-3.5

If motor and the load can not be totally separated, please select P1.37(Motor 2\3\4 as A2\A3\A4.37) to 1(Asynchronous machine static tuning), then press RUN key on keyboard panel.

4.4 Test running

DSI-400 General machine type factory setting value

Code	Factory setting	Description
P0.01	0	Speed sensorless vector control(SVC)
P0.02	0	Operation panel command channel(LED OFF)
P0.03	4	AI3(Potentiometer)

Users set motor parameters P1.00~P1.05 to correct values, after parameters auto tuning, motor operation can be directly controlled through keyboard, while frequency can be set through keyboard potentiometer.

Section V. Parameter Function Table

Caution :

The symbols in the function table are explained as follows :

“★”: indicates that the parameter setup value cannot be modified when the inverter is in the running status.

“●”: indicates that the parameter value is the actual detection record and cannot be modified.

“☆”: indicates that the parameter setup value can be modified when the inverter is in stop status and running status.

“▲”: indicates that the parameter is “Factory default parameter” and can be set only by the manufacturer, and the user is forbidden to perform any operation.

“-”: indicates that the parameter factory value is relevant to power or model, for specifications please refer to corresponding parameter description.

“Change limit” indicates if the parameter is adjustable during operation.

When PP.0 is set to non-zero value, it means that the parameter protection password is set and only when correct password is input can the user enter the parameter menu. To cancel the password, PP.0 should be set to 0.

In the user set parameter mode , parameter menu is not protected by password protection.

P group, A group are of basic function parameters, U group is the monitor function group.

5.1 Monitor function group: U0.00-U0.61

U0 parameter group is used to monitor inverter running status .Customers can check through panel for field commissioning as well as read parameter value through communication for position machine monitoring. Among which, U0.00~U0.31 is defined for running or stop monitor parameter by P7.03 and P7.04.

For specific parameter function code、 parameter name and minimum unit, please refer to the table below.

Function code	Designation	Unit
U0.00	Running frequency(Hz)	0.01Hz
Inverter current actual setting frequency		

Section V. Parameter Function Table

U0.01	Setting frequency(Hz)	0.01Hz						
Inverter current actual output frequency								
U0.02	DC bus voltage(V)	0.1V						
Detection value of DC bus voltage								
U0.03	The output voltage(V)	1V						
Inverter actual output voltage								
U0.04	Motor output current(A)	0.01A						
Valid value of motor actual current								
U0.05	The output power(kW)	0.1kW						
The calculated value of actual output power of motor								
U0.06	Output torque(%)	0.1%						
The output torque of the motor								
U0.07	DI input status	1						
IO input status. it's value is a hexadecimal digit.Each bit corresponds to each input terminal state:								
<table border="1" style="margin-left: auto; margin-right: auto;"> <tr> <td>0~14 bit</td> <td>Input status</td> </tr> <tr> <td>0</td> <td>Invalid</td> </tr> <tr> <td>1</td> <td>Valid</td> </tr> </table>			0~14 bit	Input status	0	Invalid	1	Valid
0~14 bit	Input status							
0	Invalid							
1	Valid							
U0.08	Y output status	1						

Section V. Parameter Function Table

IO output status, it's value is a hexadecimal digit.Each bit corresponds to each output terminal state :

0-9 bit	Output status
0	Invalid
1	Valid

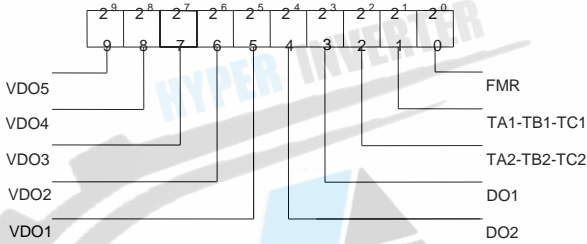

U0.09	AI1 voltage(V)	0.01V
AI1 input voltage, corrected by AC.00-AC.03		
U0.10	AI2 voltage(V)	0.01V
AI2 input voltage, corrected by AC.04-AC.07		
U0.11	AI3 voltage(V)	0.01V
AI3 input voltage, corrected by AC.08-AC.11		
U0.12	Count value	1
Fb function group count function Pb.08-Pb.09		
U0.13	Length value	1
Fb function group fixed length function Pb.05-Pb.07		
U0.14	Load speed display	1
Motor actual running speed		
U0.15	PID set point	1
PID percentage of reference value for running adjustment.		
U0.16	PID feedback	1

Section V. Parameter Function Table

PID percentage of feedback value for running adjustment.		
U0.17	PLC stage	1
PLC program running stage-display		
U0.18	PULSE pulse input frequency(kHz)	0.01kHz
Display PULSE pulse input frequency, unit 0.01Khz		
U0.19	Speed feedback(Unit 0.1Hz)	0.1Hz
synchronous speed, accurate to 0.1hz		
U0.20	Surplus running time	0.1Min
Display surplus running time, used for regular operation control.		
U0.21	AI1 voltage before correction	0.001V
AI1 voltage before correction ,used for AC function group parameter AC.00~AC.03 to correct AI1 voltage		
U0.22	AI2 voltage before correction	0.001V
AI2 voltage before correction ,used for AC function group parameter AC.04~AC.07 to correct AI2 voltage		
U0.23	AI3 voltage before correction	0.001V
AI3 voltage before correction ,used for AC function group parameter AC.08~AC.11 to correct AI3 voltage		
U0.24	Linear velocity	1m/Min
Linear velocity is calculated according to angular velocity and diameter, used for constant tension control and constant linear velocity control.		
U0.25	Current power on time	1Min
The cumulative power on time of the inverter.		
U0.26	Current running time	0.1Min
The cumulative running time of the inverter.		
U0.27	PULSE pulse input frequency	1Hz
Display PULSE pulse input frequency , unit 1Hz.		
U0.28	Communication set value	0.01%
Communication set value		
U0.29	Encoder feedback speed	0.01Hz

Section V. Parameter Function Table

PG feedback speed, accurate to 0.1 hz		
U0.30	Main frequency X display	0.01Hz
P0.03 main frequency source set frequency		
U0.31	Auxiliary frequency Y display	0.01Hz
P0.04 auxiliary frequency source set frequency		
U0.32	View arbitrary memory address value	1
To view arbitrary memory address, advanced commissioning function.		
U0.33	Reserve	0.0°
U0.34	Motor temperature	1℃
Display motor temperature. Other device temperature can also be tested through different temperature measuring point.		
U0.35	Target torque(%)	0.1%
Target torque setup.In torque control mode, it is used to check the set target torque.		
U0.36	Rotary variable position	1
It's rotor position when speed feedback.		
U0.37	Power factor angle	0.1
Current power factor angle. power factor=COS(angle), angle=0. maximum power.		
U0.38	ABZ position	0.0
ABZ incremental feedback position information of encoder calculation.		
U0.39	VF target voltage separation	1V
VF target voltage when power supply separating.		
U0.40	VF output voltage separation	1V
VF output voltage when power supply separating.		
U0.41	DI input status intuitive display	-

Section V. Parameter Function Table

<p>DI Input status</p> <p>Display DI input status intuitively, offer DI input information more detailed than U0.07, advanced display function.</p>		
U0.42	DO output status intuitive display	-
<p>DO Output status</p> <p>Display DO output status intuitively, offer DO output information more detailed than U0.08, advanced display function.</p>		
U0.43	DI function status intuitive display1	1
Display DI function status 1 intuitively ,display(function 01 –40)		
U0.44	DI function status intuitive display2	1
Display DI function status 2 intuitively ,display (function 41 –80)		
U0.45	Fault information	0
Fault information query.		
U0.46	Reserved	-
U0.47	Reserved	-
U0.48	Reserved	-

Section V. Parameter Function Table

-100.00%~100.00%		
U0.60	Running frequency(%)	0.01%
-100.00%~100.00%		
U0.61	Inverter status	1
U0.62	Current fault code	1
U0.63	Point to point communication	0.01%
U0.64	From the number of stations	1
U0.64	Torque limit	0.01%

5-2 Basic function group: P0.00-P0.28

Code	Description/Display	Setting Range		Factory Setting	Change Limit
P0.00	GP type display	G type(constant torque load type)	1	-	•
		P type(draught fan,pump load type)	2		
<p>This parameter is only for the use of viewing the factory model. It is can not be modified.</p> <p>1: It is applicable to the constant torque load of specified rated parameter</p> <p>2: It is applicable to the variable torque load of specified rated parameter(draught fan,pump load type)</p>					
P0.01	Motor 1 control mode	Speed sensorless vector control(SVC)	0	2	★
		Speed sensor vector control(FVC)	1		
		V/F control	2		
<p>0: Speed sensorless vector control</p> <p>It refers to the open-loop vector control that is generally applied to high performance control field. One inverter can only drive one motor. E.g: machine tool, centrifugal machine, fiber drawing machine, injection</p>					

Section V. Parameter Function Table

<p>molding machine' load etc.</p> <p>1: Speed sensor vector control</p> <p>It refers to the closed-loop vector control and encoder must be added to the motor end. Inverter must be matching with the same type PG card of the encoder. This control mode is suitable for high precision speed control and torque control field. One inverter can only drive one motor. E.g: high speed paper making machinery , hoisting machinery , elevator' load etc.</p> <p>2: V/F control</p> <p>V/F control mode is suitable for fields that load demand is not high or one inverter can drive multiple motors. E.g: draught fan, pump' load etc.</p> <p>Tips: Motor parameters must be identified before choosing vector control mode. Only accurate motor parameters can play the advantage of vector control mode. Users can get better performance by adjusting speed regulator group P2 parameters (motor 2, motor 3, motor 4 respectively for group A2, A3, A4)</p> <p>VFC is generally used for permanent magnet synchronous motor, while part of the small power applications can select V/F control mode. DSI-400 series support specific models of permanent magnet synchronous motor sensorless vector control mode. Please refer to DSI-400 users manual and DSI-400S dedicated users manual for using method.</p>					
P0.02	Command source selection	Operation panel command channel(LED off)	0	0	☆
		Terminal command channel(LED on)	1		
		Serial port communication command channel(LED flashing)	2		
<p>Inverter control commands include: run, stop, forward rotation (FWD), Reserved rotation (REV), forward jog (FJOG), Reserved jog (RJOG), etc.</p> <p>0: Operation panel command channel ("LOCAL/REMOT" LED off);</p> <p>Perform running command control with RUN, MF.K and STOP/RESET keyson the operation panel.</p> <p>1: Terminal command channel ("LOCAL/REMOT" LED on);</p> <p>Perform running command control with multifunctional input terminals such as FWD, REV, FJOG, RJOG, and so on.</p> <p>2: Serial port communication command channel ("LOCAL/REMOT" LED flashing).</p> <p>The running command is given by the host computer via the communication mode. For the communication protocol, please refer to "PD group communication parameters"and supplementary explanation of corresponding communication card for details.</p>					
P0.03	Main frequency source X selection	Digital setup(Preset frequency P0.08, UP/DOWN can be modified, power off without memory)	0	4	★

Section V. Parameter Function Table

	Digital setup(Preset frequency P0.08, UP/DOWN can be modified, power off with memory)	1
	AI1	2
	AI2	3
	AI3(Potentiometer)	4
	Pulse setup(DI5)	5
	MS command	6
	Simple PLC	7
	PID setup	8
	Communication setup	9

This parameter is used to select the main reference frequency input channel. Totally 10 main reference frequency channels:

0: Digital setup(power off without memory)

Initial value of set frequency equals to P0.08 "preset frequency". User can change inverter set frequency value through keyboard \wedge key and \vee key (or multi-function input terminal UP,DOWN).

Inverter power on after powered off, frequency set value restored to P0.08 "Preset frequency".

1: Digital setup(power off with memory)

Initial value of set frequency equals to P0.08 "preset frequency". User can change inverter set frequency value through keyboard \wedge key and \vee key (or multi-function input terminal UP,DOWN).

Inverter power on after powered off, frequency set value restored to the value that equals to setup of last power off time. Correction is memorized through keyboard \wedge key and \vee key or terminal UP,DOWN.

What needs to be reminded is, P0.23 is "Digital setup frequency memory selection". P0.23 is used to select correction whether to be memorized or cleared and is relevant to stop, irrelevant to power off memory, please pay attention during operation.

2: AI1

3: AI2

4: AI3(Potentiometer)

Frequency is determined by analog input terminal. DSI-400 series control board offers 2 analog input terminal(AI1, AI2), optional device TZ5PC1 card can offer 1 isolated analog input terminal(AI3x).

AI1, AI2 can be chosen as 0V~10V voltage input as well as 0mA~20mA current input by the jumper J3, J4 on control board.

Section V. Parameter Function Table

AI1、AI2 input voltage value has a corresponding relationship with target frequency, users can choose them at will. DSI-400 offers 5 groups of corresponding relation curve, which 3 of them are linear relationship(2-point correspondence), 2 of them are 4-point correspondence(any curve among them). User can set through P4 group or A6 function code.

Function code P4.33 is used to set AI1–AI2-channel analog input. Choose 1 curve among the 5 respectively. For specific correspondence please refer to P4、A6 groups.

5: Pulse setup(DI5)

Pulse setup is set through terminal pulse. Signal standard: voltage range 9V–30V, frequency range 0kHz–100kHz. Set pulse can be only input through multi-function input terminal DI5.

Relationship between DI5 input pulse frequency and corresponding settings is set through P4.28–P4.31. It is linear relationship(2-point correspondence). Pulse input 100.0% refers to the percentage of P0.10 .

6: MS command

MS command running mode is set through different combination mode of digital input DI terminal. There are 4 MS command terminals with 16 status of DSI-400 series. PC group function codes correspond to 16 "MS command". "MS command" is percentage relative to P0.10(maximum frequency).

When digital input terminal DI is used as MS command terminal, user should set through P4 group.For specifications please refer to P4 group.

7: Simple PLC

When frequency source is set to 7, running frequency source can be switched to any frequency command during 1–16.

User can set frequency command retention time and acceleration/deceleration time respectively.For specifications please refer to PC group .

8: PID

Running frequency is the output of PID control process. Generally used for field process closed-loop control.

When PID is chosen, user should set relevant parameters of PA group "PID function".

9: Communication setup

Communication setup refers to main frequency source that setting through communication method of position machine.

P0.04	Auxiliary frequency source Y selection	Digital setup(preset frequency P0.08, UP/DOWN adjustable, power off without memory)	0	0	★
		Digital setup(preset frequency P0.08, UP/DOWN adjustable, power off with memory)	1		

Section V. Parameter Function Table

		AI1	2			
		AI2	3			
		AI3(Potentiometer)	4			
		PULSE setup (DI5)	5			
		MS command	6			
		Simple PLC	7			
		PIDsetup	8			
		Communication setup	9			
<p>When the auxiliary frequency source is used as independent frequency reference channel (i.e. frequency source switching from X to Y), it is used in the same way as the relative specifications of P0.03.</p> <p>When the auxiliary frequency source is used as overlap reference (i.e. frequency source selection switching from X plus Y or X to X plus Y), it has special points as follows:</p> <ol style="list-style-type: none"> 1. When the auxiliary frequency source is digital reference, the preset frequency (P0.08) is nonsensical, and it needs to adjust the main reference frequency through the keys “^” and “\” of the keyboard (or UP and DOWN of multifunctional input terminals). 2. When the auxiliary frequency source is analog input reference (AI1、AI2、AI3) or pulse input reference, 100% of input setup is relative to the auxiliary frequency source range, and can be set through P0.05 and P0.06. 3. When the frequency source is pulse input reference, it is similar to the analog value. <p>Prompt: There is difference between the auxiliary frequency source Y selection and the main frequency source X setup value. That is to say, P0.03 and P0.04 cannot use the same frequency reference channel.</p>						
P0.05	Auxiliary frequency source Y range selection	Relative to maximum frequency	0	0	☆	
		Relative to frequency source X	1			
P0.06	Auxiliary frequency source Y range	0%~150%		0	☆	
<p>When the frequency source selection is frequency overlap reference(P0.07 is set to 1、3 or 4), it is used to determine the adjustment range of auxiliary frequency source. P0.05 is used to determine the relative object within the range. If it is relative to main frequency, that range will vary with the main frequency X.</p>						
P0.07	Frequency source stacking selection	1bit	Frequency source selection		00	☆
		Main frequency source X		0		
		Main /auxiliary operation result (10bit determine operation relationship)		1		

Section V. Parameter Function Table

		Switching between X & Y		2		
		Switching between X & option 1		3		
		Switching between Y & option 1		4		
		10bit	Relationship between main /auxiliary frequency source			
		Main+auxiliary		0		
		Main-auxiliary		1		
		MAX(main frequency source X, auxiliary frequency source Y)		2		
		MIN(main frequency source X, auxiliary frequency source Y)		3		

This parameter is used to select frequency setup channel, and of realizing frequency setup through the compound of main frequency X and auxiliary frequency Y.

1bit : Frequency source selection

0: Main frequency source X

Main frequency source X is the target frequency.

1: Main /auxiliary operation result is target frequency, operation relationship see "10 bit" for details.

2: Switching between main frequency source X and auxiliary frequency source Y

When terminal 18 (frequency switching) is invalid, main frequency X is target frequency. On the contrary, auxiliary frequency Y is the target frequency.

3: Switching between main frequency X and main /auxiliary operation result

When terminal 18 (frequency switching) is invalid, main frequency X is target frequency. On the contrary, auxiliary frequency Y is the target frequency.

4: Switching between auxiliary frequency Y and main /auxiliary operation result

When terminal 18 (frequency switching) is invalid, auxiliary frequency Y is the target frequency. On the contrary, main frequency X is target frequency.

10bit : Relationship between main/auxiliary frequency source

0: Main frequency source + auxiliary frequency source Y

Operation result of main + auxiliary is target frequency. It realizes frequency stacking set function.

1: Main frequency source - auxiliary frequency source Y

Operation result of main - auxiliary is target frequency.

Section V. Parameter Function Table

<p>2: MAX(main frequency source X, auxiliary frequency source Y)</p> <p>Choose bigger absolute value of the two as target frequency</p> <p>3: MIN(main frequency source X, auxiliary frequency source Y)</p> <p>Choose smaller absolute value of the two as target frequency.</p> <p>Besides, when frequency source is main& auxiliary operation,users can set offset frequency through P0.21.By stacking offset frequency on main& auxiliary operation result,it could flexible cope with all kinds of needs.</p>						
P0.08	Preset frequency	0.00Hz to maximum frequency(It is only valid when frequency source is set to "digital setting")			50.00Hz	☆
<p>When set the frequency source to "digital setting" or "terminal UP/DOWN", the parameter value is the initial value of the inverter frequency digital setting.</p>						
P0.09	Running direction	Consistent direction	0	0	☆	
		Reserved direction	1			
<p>Modification of this parameter can change the rotary direction of the motor without changing any other parameters, which is equivalent to the role of switching the rotary direction through adjusting any two lines of the motor (U, V and W).</p> <p>When needing to change the rotary direction of the motor, users can modify this parameter rather than adjust the wiring of the motor.</p> <p>Caution: When the function code is restored to the factory default value, this parameter value is restored to 0, which should be used prudently in the applications where the motor rotary direction is not allowed to change.</p>						
P0.10	Maximum frequency	50.00Hz~500.00Hz			50.00Hz	★
<p>When analog input, pulse input(DI5), MS command etc are used as frequency source, their respective 100% are relatively calibrated through P0.10.</p> <p>DSI-400 maximum frequency could reach 3200Hz. Users can set decimal digits of frequency command through P0.22 to balance the index of frequency command resolution and frequency input range.</p> <p>When P0.22 is set to 1,frequency resolution ratio is 0.1Hz, P0.10 setting range is 50.0Hz~3200.0Hz; When P0.22 is set to 2, frequency resolution ratio is 0.01Hz, P0.10 setting range is 50.00Hz~320.00Hz.</p>						
P0.11	Frequency source upper limit	P0.12 setup	0	0	★	
		A1	1			
		A2	2			
		A13(Potentiometer)	3			
		PULSE setup	4			

Section V. Parameter Function Table

		Communication setup	5		
<p>It defines the source of frequency upper limit. Frequency upper limit comes from digital setup (P0.12) or analog input channel. When upper limit is set through analog input, 100% of analog input corresponds to P0.12.</p> <p>E.g : When winding control field is in the torque control mode, to avoid material break phenomenon, users can set upper limit frequency through analog value. When running frequency reaches value of upper limit , inverter maintains operation at the upper limit frequency.</p>					
P0.12	Frequency upper limit	Frequency lower limit(P0.14) to maximum frequency(P0.10)	50.00Hz	☆	
P0.13	Frequency upper limit offset	0.00Hz~maximum frequency P0.10	0.00Hz	☆	
<p>When upper limit is set through analog value or PULSE setup, P0.13 will be used as analog valueoffset. The addition of offset frequency and analog setup value of frequency upper limit is used as the final setup value of frequency upper limit.</p>					
P0.14	Frequency lower limit	0.00Hz to frequency upper limit P0.12	0.00Hz	☆	
<p>When the running frequency of the inverter is lower than the frequency lower limit, it can select to run at frequency lower limit or stop the inverter. Refer to P8.14 function code for details.</p>					
P0.15	Carrier frequency	0.8kHz~8.0kHz	-	☆	
<p>This function is used to adjust the carrier frequency of the inverter. By adjusting the carrier frequency, the motor noise can be reduced, the resonance of the mechanical system can be avoided, so that the leakage current to the ground and the interference of the inverter can be reduced.</p> <p>When the carrier wave frequency is low, the output current higher harmonic component will be increased, the motor loss will be increased, and the motor temperature rise will also be increased.</p> <p>When the carrier wave frequency is high, the motor loss is reduced, and the motor temperature rise is reduced, but the inverter loss and inverter temperature rise will be increased, and thus the interference will be increased.</p> <p>The adjustment of carrier frequency will influence the following items on the performance:</p>					
Carrier frequency		low→	high		
Motor noise		big→	small		
Output current waveform		poor→	well		
Motor temperature rise		high→	low		
Inverter temperature rise		low→	high		
Leakage current		small→	large		
Radiation interference		small→	big		

Section V. Parameter Function Table

<p>Different power of inverter is set with different carrier frequency by the factory. Though user could modify it , attention should be paid: if carrier frequency is set higher than the factory set value, it will lead to inverter radiator temperature rise increasing. User should take inverter derating use, or there will be danger of overheating alarm.</p>					
P0.16	Carrier frequency adjusting with temperature	No	0	0	☆
		Yes	1		
<p>Carrier frequency adjusting with temperature refers to the detecting of radiator temperature. When the temperature is high , carrier frequency automatically decreased to reduce the inverter temperature rise. On the contrary , when the temperature is low, carrier frequency gradually restored to the set value.This function could help to reduce the chance of inverter overheating alarm.</p>					
P0.17	Acceleration time 1	0.00s-65000s	-		☆
P0.18	Deceleration time 1	0.00s-65000s	-		☆
<p>The acceleration time means the time t1 needed for the inverter to accelerate from 0Hz to the reference frequency(P0.25).</p> <p>The deceleration time means the time t2 needed for the inverter to decelerate from the reference frequency (P0.25) to 0Hz.</p> <p>The description of acceleration and deceleration time are as shown in Fig.5.1 :</p>					
<p>Fig.5-1 Acceleration/deceleration time schematic diagram</p>					
<p>DSI-400 totally offers 4 groups of speed-up/speed-down time for selection,you can shift through digital input terminal DI,4 groups of them are shown as follows:</p>					
<p>GROUP 1: P0.17、P0.18;</p>					
<p>GROUP 2: P8.03、P8.04;</p>					
<p>GROUP 3: P8.05、P8.06;</p>					

Section V. Parameter Function Table

GROUP 4: P8.07、P8.08.					
P0.19	Acc./dec. time unit	1second	0	1	★
		0.1 seconds	1		
		0.01 seconds	2		
<p>DSI-400 offers 3 kinds of speed-up /speed down time unit to meet the need of all kinds of scene.Respectively for 1 second、0.1 seconds and 0.01 seconds.</p> <p>Caution: Decimal places as well as corresponding acceleration/deceleration time of the 4 groups may be changed when modifying this function parameter,special attention should be paid in the process of application.</p>					
P0.21	Auxiliary frequency source offset frequency	0.00Hz~Maximum frequencyP0.10	0.00Hz	☆	
<p>It is valid only at the time of main/auxiliary operation is chosen.</p> <p>When frequency source is main / auxiliary operation(P0.21 as offset frequency) ,it could make frequency set more flexible by stacking offset frequency on main& auxiliary operation as the final frequency set value.</p>					
P0.22	Frequency command resolution	0.01Hz	2	2	★
<p>This parameter is used to determine all the function code resolution which is relevant to frequency.</p> <p>Caution: Parameter (relating to frequency) decimal digits and corresponding frequency value will change through modifying P0.22. Special attention should be paid during operation.</p>					
P0.23	Digital setup frequency memory selection upon stop	Without memory	0	0	☆
		Memory	1		
<p>This function is only valid when frequency source is digital setup.</p> <p>0: Without memory</p> <p>Upon power fault or stop of the inverter, set the frequency value back to the setup value of "Preset Frequency" (P0.08). Frequency modification which set through keyboard "∧"、"∨" or terminal UP、DOWN is cleared.</p> <p>1: Memory</p> <p>Digital setup frequency is the retention that reserved at last stop time. Keyboard "∧"、"∨" or terminal UP、DOWN to make the correction valid.</p>					
P0.24	Motor selection	Motor 1	0	0	★
		Motor 2	1		
DSI-400 support applications that driving 4 motors in time-sharing. 4 motors can be set motor					

Section V. Parameter Function Table

<p>nameplate parameters, independent parameter tuning, control mode, parameters relating to operation performance respectively.</p> <p>Motor 1 corresponding function groups are P1 group and P2 group. Motor 2, motor 3, motor 4 corresponding groups are A2 group, A3 group and A4 group respectively.</p> <p>Users select current motor through P0.24 function code as well as digital input terminal DI. When function code selection conflicting with terminal DI selection, DI terminal selection is priority.</p>						
P0.25	Acceleration / deceleration reference frequency	Maximum frequency(P0.10)	0	0	★	
		Set frequency	1			
		100Hz	2			
<p>Acceleration / deceleration time means the time needed for the inverter varying from 0Hz to the frequency of P0.25, Fig5.1 is acceleration / deceleration time schematic diagram.</p> <p>When P0.25 is chosen to 1, acceleration / deceleration time is connected with set frequency. If set frequency change frequently, the motor acceleration will change, attention should be paid in applications.</p>						
P0.26	Frequency UP/DOWN reference upon running	Running frequency	0	0	★	
		Set frequency	1			
<p>This parameter is only valid when frequency source is digital setting.</p> <p>To select (through keyboard \wedge、\vee key or terminal UP/DOWN) the modifying method of set frequency, namely, target frequency is increasing/decreasing based on the running frequency or setting frequency.</p> <p>The difference between the two settings become apparently in inverter acceleration and deceleration process.</p>						
P0.27	Command source & frequency source binding	1bit	Operation panel command bound frequency source selection		000	☆
		Without binding		0		
		Digital setup frequency source		1		
		AI1		2		
		AI2		3		
		AI3(Potentiometer)		4		
		PULSE pulse setup(DI5)		5		
		MS command		6		
Simple PLC		7				

Section V. Parameter Function Table

		PID	8
		Communication setup	9
	10bit	Terminal command bound frequency source selection	
		Without bound	0
		Digital setup frequency source	1
		AI1	2
		AI2	3
		AI3(Potentiometer)	4
		PULSE pulse setup(DI5)	5
		MS command	6
		Simple PLC	7
		PID	8
		Communication setup	9
	100bit	Communication command binding frequency source selection	
		Without bound	0
		Digital setup frequency source	1
		AI1	2
		AI2	3
		AI3(Potentiometer)	4
		PULSE pulse setup(DI5)	5
		MS command	6
		Simple PLC	7
		PID	8
		Communication setup	9

It defines bound combination between 3 running command channels and 9 frequency setup channels, which is easy to achieve synchronous switching.

Frequency setup channels above have the same definition with P0.03 "main frequency source X

Section V. Parameter Function Table

selection", please refer to P0.03 for details. Different running command channels can bind the same frequency setup channel. When the command source is valid during command source & frequency source binding, set frequency source of P0.03~P0.07 is invalid.

P0.28	Communication expansion card	Modbus communication card	0	0	☆
		Profibus.DP communication card	1		

DSI-400 series offers 3 kinds of communication mode. All of the 3 need to be equipped with optional communication card .And they can not be used at the same time.

P0.28 is used to set the type of the optional communication card. When user replace the communication card , P0.28 should be properly set.

5-3 Parameters for motor 1: P1.00-P1.37

Code	Description/Display	Setting Range	Factory Setting	Change Limit	
P1.00	Motor type selection	General asynchronous motor	0	0	★
		Variable frequency asynchronous motor	1		
P1.01	Rated power	0.1kW~1000.0kW	-	★	
P1.02	Rated voltage	1V~2000V	-	★	
P1.03	Rated current	0.01A~655.35A(Inverter power ≤ 55kW)	-	★	
		0.1A~6553.5A(Inverter power >55kW)			
P1.04	Rated frequency	0.01Hz~maximum frequency	-	★	
P1.05	Rated revolving speed	1rpm~65535rpm	-	★	

Function codes above are motor nameplate parameters. No matter VF control or vector control is the chosen mode, users should accurately set the relating parameter according to the motor nameplate.

For better VF or vector control performance, users should tune the motor parameter. The accuracy of the regulation results has intimate relationship with the accuracy of set motor nameplate parameters.

P1.06	Asynchronous motor stator resistance	0.001Ω~65.535Ω(Inverter power ≤55kW)	-	★
		0.0001Ω~6.5535Ω(Inverter power >55kW)		
P1.07	Asynchronous motor rotor resistance	0.001Ω~65.535Ω(Inverter power ≤55kW)	-	★
		0.0001Ω~6.5535Ω(Inverter power >55kW)		
P1.08	Asynchronous motor	0.01mH~655.35mH(Inverter power ≤55kW)	-	★

Section V. Parameter Function Table

	leakage inductance	0.001mH-65.535mH(Inverter power >55kW)			
P1.09	Asynchronous motor mutual inductance	0.1mH-6553.5mH(Inverter power <=55kW) 0.01mH-655.35mH(Inverter power >55kW)	-	★	
P1.10	Asynchronous motor no load current	0.01A-P1.03(Inverter power <=55kW) 0.1A-P1.03(Inverter power >55kW)	-	★	
<p>P1.06-P1.10 are parameters for asynchronous motor. Generally, motor nameplate doesn't contain such parameters, users can get them through inverter auto tuning. Among them, 3 parameters (P1.06-P1.08) can be get through " asynchronous motor static tuning", while all the 5 parameters as well as encoder phase ,current loop PI etc can be get through "asynchronous motor complete tuning". When change the motor rated power (P1.01) or motor rated voltage (P1.02), inverter would automatically modify the P1.06-P1.10 parameter value and restore them to common standard of Y series motor parameter.</p> <p>If the asynchronous motor is unable to be tuned, users could input above parameters with factory offered motor value.</p>					
P1.27	Encoder pulses number	1-65535	2500	★	
<p>To set ABZ or UVW incremental encoder pulse number per revolution.</p> <p>In the speed sensor vector control mode, P1.27 must be set accurately. Or motor would not normally operate.</p>					
P1.28	Encoder type	ABZ incremental encoder	0	0	★
		Reserved	1		
		Rotary transformer	2		
		Reserved	3		
		Reserved	4		
<p>DSI-400 support multiple encoder types. Different encoder should be equipped with different PG card. For specifications please refer to Appendix IV. All the 5 encoders are suitable for synchronous motor, while only ABZ incremental encoder and rotary transformer are suitable for asynchronous motor.</p> <p>After installing the PG card, make sure that P1.28 is accurate according to actual situation.</p>					
P1.30	ABZ incremental encoder AB phase	Forward	0	0	★
		Reserve	1		
<p>This function code is only valid to ABZ incremental encoder(P1.28=0). It is used to set ABZ incremental encoder AB signal phase sequence.</p> <p>It is valid for both synchronous motor and asynchronous motor. Users could get ABZ encoder AB phase sequence through asynchronous motor complete tuning or synchronous motor no-load tuning.</p>					

Section V. Parameter Function Table

P1.34	Rotary transformer pole pairs	1~65535	1	★	
Rotary transformer is equipped with pole pairs. When using the encoder, correct parameters must be set to it.					
P1.36	PG dropped inspection time	0.0s: no action 0.1s~10.0s	0.0s	★	
It is used to set inspection time of encoder disconnection fault. When feedback signal is 0.0s, encoder disconnection fault will not be inspected.					
If inverter detected disconnection fault, and the feedback value exceeded the P1.36 setup range. Inverter fault alarm No. 20= E.PG1.					
P1.37	Tuning selection	Without operation	0	0	★
		Asynchronous static tuning 1	1		
		Asynchronous complete tuning	2		
		Asynchronous static tuning 2	3		
<p>Caution: Correct motor ratings must be set before tuning</p> <p>0: No operation, tuning is forbidden.</p> <p>1: Asynchronous motor static tuning 1</p> <p>It is used for occasions that asynchronous motor and the load are not easily torn off, which may lead to complete tuning invalid. Correct motor type and motor nameplate parameters P1.00~P1.05 must be set before static tuning. User could get P1.06~P1.08 through tuning.</p> <p>Action description: Set P1.37 to 1 and then press RUN button, inverter will carry out asynchronous static tuning.</p> <p>2 : Asynchronous complete tuning</p> <p>Asynchronous complete tuning can guarantee inverter dynamic control performance. Motor and the load should be disconnected to keep motor complete status.</p> <p>In the process of asynchronous complete tuning , asynchronous complete tuning is taken first, and then accelerate to 80% of motor rated frequency according to P0.17. After keeping the state for a period of time, then decelerate to stop according to P0.18 and stop tuning.</p> <p>Before asynchronous complete tuning , users should set motor type and motor nameplate parameters P1.00~P1.05 as well as encoder type and encoder pulse numbers P1.27、 P1.28.</p> <p>Inverter can get 5 motor parameters P1.06~P1.10 as well as AB phase sequence P1.30, vector control current loop PI parameter P2.13~P2.16 from tuning.</p> <p>Action description: Set P1.37 to 2 and then press RUN button, inverter will carry out asynchronous complete tuning.</p> <p>3 : Asynchronous motor static tuning</p>					

It is used for no encoder

5-4 Vector control function group: P2.00-P2.23

P2 group function codes are valid for vector control and invalid for V/F control.

Code	Description/Display	Setting Range	Factory Setting	Change Limite
P2.00	Speed loop proportional gain1	1~100	30	☆
P2.01	Speed loop integration time1	0.01s~10.00s	0.50s	☆
P2.02	Switching frequency1	0.00~P2.05	5.00Hz	☆
P2.03	Speed loop proportional gain 2	0~100	20	☆
P2.04	Speed loop integration time 2	0.01s~10.00s	1.00s	☆
P2.05	Switching frequency 2	P2.02~maximum frequency	10.00Hz	☆

Users could choose different speed loop PI parameters under different running frequency. When running frequency is less than the switching frequency(P2.02), adjusting parameters for speed loop PI are P2.00 and P2.01. When running frequency is greater than the switching frequency (P2.02), adjusting parameters for speed loop PI are P2.03 and P2.04. Speed loop PI parameters between switching frequency1 and switching frequency2 are two groups of linear switching. As shown in fig.5.2:

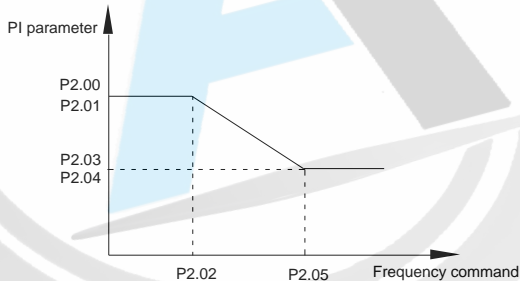

Fig.5-2PI parameter schematic diagram

Users can adjust vector control speed dynamic response characteristics through setting proportional coefficient and integration time of the speed regulator.

Both increasing proportional gain and reducing integration time can accelerate the speed loop dynamic response. But excessive proportional gain or insufficient integration time may lead to system oscillation.

Suggestions for regulating method:

If the factory parameters can not meet the requirements, users can fine-tuning it on the basis of factory value parameters. First increase the proportional gain to restrain system oscillation, then reduce integration time so that system has fast response characteristic and smaller overshoot.

Notice: Improper PI parameter setting may lead to excessive speed overshoot, even voltage fault

Section V. Parameter Function Table

during overshoot drop.				
P2.06	Vector control slip gain	50%~200%	100%	☆
<p>This parameter is used to adjust motor steady speed precision for zero-speed sensor vector control mode. Please turn up the parameter value when with load motor running in low speed. On the contrary, when the with load motor running in high speed, please turn down the parameter value.</p> <p>This parameter is also used to adjust the output current value with the same load for speed sensor vector control.</p>				
P2.07	Speed-loop filter time	0.000s~0.100s	0.015s	☆
<p>In vector control mode, speed-loop regulator outputs torque current command. P2.07 is used to filter the torque command.</p> <p>Generally speaking, the parameter needs not to be modified. Users could properly increase the filtering time when speed fluctuation is relatively big, and decrease the value when motor oscillation occurs.</p> <p>If filtering time is small, inverter output torque might fluctuate greatly, but response speed will be fast.</p>				
P2.09	Torque upper limit source in speed control mode	P2.10	0	0 ☆
		A11	1	
		A12	2	
		A13(Potentiometer)	3	
		PULSE setup	4	
		Communication setup	5	
		Min(A11,A12)	6	
		Max(A11,A12)	7	
P2.10	Torque upper limit digital setup in speed control mode	0.0%~200.0%	150.0%	☆
<p>In speed control mode, inverter maximum torque output is controlled by torque upper limit.</p> <p>Range for 1-7 selections of P2.09 are corresponding to the setting range of P2.10.</p> <p>P2.09 is used to select torque upper limit source. When P2.09 is set through analog, PULSE setup, communication setup, which 100% corresponding to P2.10. 100% of P2.10 is the rated torque of the inverter.</p>				

Section V. Parameter Function Table

P2.11	Torque upper limit source in speed control mode (regenerative)	P2.10	0	0	☆
		AI1	1		
		AI2	2		
		AI3(Potentiometer)	3		
		PULSE setup	4		
		Communication setup	5		
		Min(AI1,AI2)	6		
		Max(AI1,AI2)	7		
P2.12	Torque upper limit digital setup in speed control mode (regenerative)	0.0%~200.0%	150.0%	☆	
P2.13	Excitation regulation proportional gain	0~20000	2000	☆	
P2.14	Excitation regulation integration gain	0~20000	1300	☆	
P2.15	Torque regulation proportional gain	0~20000	2000	☆	
P2.16	Torque regulation integration gain	0~20000	1300	☆	
<p>Vector control current-loop PI regulation, which is automatically obtained after asynchronous motor complete tuning or synchronous motor complete tuning. It generally needs not to be modified.</p> <p>Caution: Integration regulator of current loop directly set integration gain without taking integration time as the dimension. Excessive current loop PI gain may lead oscillation to the entire control loop circuit.</p> <p>If current oscillation or torque fluctuation is relatively big, users could manually turn down the PI proportional gain or integration gain.</p>					
P2.17	Speed loop intergral separation selection	Disable	0	0	☆
		enable	1		
P2.21	Max torque coefficient of field weakening area	50~200%	100%	☆	

Section V. Parameter Function Table

P2.22	Regenerative power limit selection	Disable	0	0	☆
		enable	1		
P2.23	Regenerative power limit	0.0~200.0%		Mode dependent	☆

5-5 V/F control group: P3.00-P3.26

This function group is only valid for V/F control mode.

V/F control is suitable for general load such as draught fan, pump. It is also appropriate for situations where one inverter driving multiple motors or there is big difference between inverter power and motor power.

Code	Description/Display	Setting Range		Factory Setting	Change Limit
P3.00	V/F curve setup	Beeline V/F	0	0	★
		Multi-point V/F	1		
		VF complete separation mode	10		
		VF semi separation mode	11		

This parameter defines the V/F setup mode so as to meet the requirements of various load characteristics.

0: Beeline V/F

It is suitable for the ordinary constant torque load.

1: Multi-point V/F

It is suitable for special loads such as dehydrator and centrifugal machine. It can be self-defined. Refer to the description of functional codes of Group F1-07 to F1-12 for details.

2~9: Reserved

10: VF complete separation mode

Inverter output frequency and output voltage are mutually independent. Output frequency is decided by frequency source, while output voltage is decided by P3.13(VF separation voltage source).

VF complete separation mode is generally applied in induction heating, inverter power supply, torque motor control fields etc.

11: VF semi separation mode

In this case, V is proportional to F. Proportional relationship can be set by the voltage source P3.13.

Section V. Parameter Function Table

<p>The relationship between V&F is connected with P1 group(motor rated voltage and rated frequency).</p> <p>Suppose that voltage source input is X (X from 0~100%), the V,F relationship is:</p> $V/F=2*X*(\text{Motor rated voltage})/(\text{Motor rated frequency})$				
P3.01	Torque boost value	0.0%~30%	-	★
P3.02	Torque boost cut-off frequency	0.00~Maximum frequency	50.00Hz	★
<div style="text-align: center;"> <p>V1:Manual torque boost voltage Vb:Maximum output voltage f1:Cutt-off frequency of torque boost fb:Rated running frequency</p> <p>Fig. 5-3 Manual torque boost schematic diagram</p> <p>To compensate the low frequency torque characteristics of V/F control, boost compensation should be made to inverter low frequency output voltage.</p> <p>Torque hoist: it will be set according to the percentage of input rated voltage to the inverter. Below are explanations of setting torque increase:</p> <ol style="list-style-type: none"> 1) When the torque hoist is set as 0.0%, the inverter will aYpt auto torque hoist. 2) This parameter can be properly hoisted for small motor, while for large motor; the parameter can be properly decreased. 3) If the torque hoist is set to be too large, the motor may be overheated, and the inverter may be over-current. <p>Torque hoist cut-off frequency: As shown in Fig. 5.3, the torque hoist is valid when the cutoff frequency below this setting. Otherwise, the torque hoist will be invalid.</p> </div>				
P3.03	Multi-point V/F frequency point F1	0.00Hz~P3.05	0.00Hz	★
P3.04	Multi-point V/F voltage point V1	0.0%~100.0%	0.0%	★
P3.05	Multi-point V/F frequency point F2	P3.03~P3.07	0.00Hz	★
P3.06	Multi-point V/F voltage point	0.0%~100.0%	0.0%	★

Section V. Parameter Function Table

	V2			
P3.07	Multi-point V/F frequency point F3	P3.05~Motor rated frequency(P1.04)Note: Motor 2\3\4 rated frequency respectively A2.04\A3.04\A4.04	0.00Hz	★
P3.08	Multi-point V/F voltage point V3	0.0%~100.0%	0.0%	★

Six parameters of P3.03 to P3.08 define the multi-point V/F curve.

The setup value of multi-point V/F curve is generally set in accordance with the load characteristics of the motor.

Caution:

1) It must be set as follows: $V1 < V2 < V3$, $F1 < F2 < F3$. Fig.5.4 is schematic diagram for multi-point V/F curve.

2) If the voltage is set too high at the time of low frequency, it may cause overheating and even burning of the motor as well as stall over current or over current protection of the inverter.

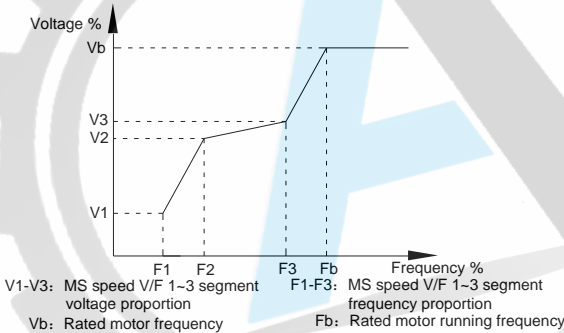

Fig. 5-4 Multi-point V/F curve setup schematic diagram

P3.09	V/F slip compensation gain	0%~200.0%	0.0%	☆
-------	----------------------------	-----------	------	---

This parameter is only valid for asynchronous motor.

V/F slip compensation can compensate asynchronous motor speed deviation ,in this way ,motor rotary speed could be maintained in basically stable state during load change. In general, 100% corresponds to the rated slip of the motor with rated load. For motor rated slip , it can be get through auto calculation of P1 motor rated frequency and rated revolving speed.

The slip compensation gain adjustment may be performed referring to the following principle: When the load is rated load, and the slip compensation coefficient is set to 100%, the rotary speed of the motor is close to the reference speed.

P3.10	V/F over-excitation gain	0~200	64	☆
-------	--------------------------	-------	----	---

The role of over excitation gain function is to suppress the rise of bus voltage during the inverter deceleration process, thus avoiding occurrence of over voltage fault due to bus voltage exceeding over

Section V. Parameter Function Table

<p>voltage protection limitation value. The higher the over excitation gain is, more powerfully the suppression effect is. The setting is described as follows:</p> <p style="margin-left: 20px;">In the applications where over-voltage alarm easily occurs, it needs to improve the over-excitation gain. Excessive over-excitation gain easily lead to increasing of output current .Users should keep the balance during operation.</p> <p style="margin-left: 20px;">In the applications where the inertia is very low, the over excitation gain is set to 0, while in the applications where there is brake resistor ,the over excitation gain is set to 0 as well.</p>				
P3.11	VF oscillation suppression gain	0~100	-	☆
<p>When the motor has no oscillation, please select this gain to 0. Only when the motor has obvious oscillation and Yes not run normally can the gain be properly increased. The bigger the gain is, the better oscillation suppression result will be.</p> <p style="margin-left: 20px;">The gain shall be set as small as possible under the condition that the oscillation is suppressed effectively so as to avoid high influences on the V/F operation.</p> <p style="margin-left: 20px;">Accurate motor rated current and no-load current parameters are required during using oscillation suppression function, or VF oscillation suppression effect will not be excellent.</p>				
P3.13	VF separation voltage source		0	☆
		Digital setup(P3,14)	0	
		AI1	1	
		AI2	2	
		AI3(Potentiometer)	3	
		PULSE pulse setup(DI5)	4	
		MS command	5	
		Simple PLC	6	
		PID	7	
		Communication setup	8	
		100% corresponding to the rated motor voltage (P1.02、A4.02、A5.02、A5.02)		
P3.14	VF separation voltage digital setup	0V~rated motor voltage	0V	☆
<p>VF separation is generally applied to induction heating control, inverter power supply control and torque motor control etc.</p> <p style="margin-left: 20px;">In VF separation control mode, output voltage can be set through function code P3.14, analog value, MS command , PLC, PID or communication setup.</p> <p style="margin-left: 20px;">When P3.13 is non-numeric setup, each 100% of the setting corresponds to rated moter voltage. When output setting percentage is negative, it's absolute value is the valid setting value.</p>				

Section V. Parameter Function Table

<p>0: Digital setup(P3.14)</p> <p style="padding-left: 20px;">Voltage is directly set through P3.14.</p> <p>1: AI1</p> <p>2: AI2</p> <p>3: AI3(Potentiometer)</p> <p style="padding-left: 20px;">Voltage is set through analog input terminal.</p> <p>4: PULSE pulse setup(DI5) voltage set through terminal pulse.</p> <p style="padding-left: 20px;">Pulse setup signal specification: voltage range 9V~30V, frequency range 0kHz~100kHz.</p> <p>5: MS command voltage source is MS command.</p> <p style="padding-left: 20px;">Corresponding relationship between set signal and set voltage is determined through P4 group and PC group.</p> <p>6: Simple PLC</p> <p style="padding-left: 20px;">When voltage source is simple PLC, output voltage is set through PC group parameters.</p> <p>7: PID</p> <p style="padding-left: 20px;">Output voltage through PID closed loop. For specifications please refer to PA group for PID detailed description.</p> <p>8: Communication setup</p> <p style="padding-left: 20px;">Communication setup refers to voltage that set by position machine through communication mode.</p> <p style="padding-left: 20px;">When the above voltage source selection is 1~8, 0~100% corresponds to output voltage 0V~motor rated voltage.</p>				
P3.15	VF separation voltage rise time	0.0s~1000.0s	0.0s	☆
P3.16	VF separation voltage decline time	0.0s~1000.0s	0.0s	☆
<p>P3.15 refers to the time that needed for output voltage varying from 0V to motor rated voltage. As shown in fig.5-5.</p>				

Section V. Parameter Function Table

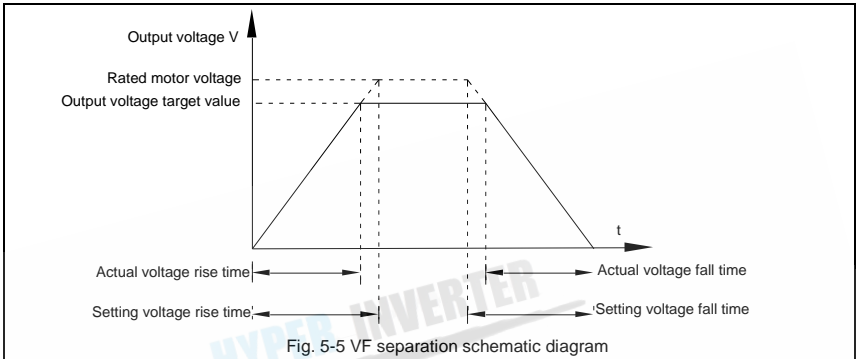

Fig. 5-5 VF separation schematic diagram

P3.17	Stop mode selection for VF separation voltage	Frequency and voltage decline to 0 independently	0	0	☆
		Frequency declining after voltage decline to 0	1		
P3.18	Current limit level	50~200%		150%	★
P3.19	Current limit selection	Disable	0	1	★
		Enable	1		
P3.20	Current limit gain	0~100		20	☆
P3.21	Compensation factor of Speed multiplying current limit	50~200%		50%	★
P3.22	voltage limit	650.0~800.0v		770.0	★
P3.23	voltage limit selection	Disable	0	1	★
		Enable	1		
P3.24	Frequency gain for voltage limit	0~100		30	☆
P3.25	voltage gain for voltage limit	0~100		30	☆
P3.26	Frequency rise threshold during voltage limit	0-50Hz		5	★

5-6 Input terminal: P4.00-P4.40

DSI-400 series inverter has 7 multifunctional digital input terminals (DI1 to DI7), of which DI5 can be used as high-speed pulse input terminal, and DSI-400 series inverter also has 2 analog input terminals. If system needs more input/output terminal, it can be equipped with multi-function input/output expansion card and 1 analog input terminal(AI3x).

Multi-function input/output expansion card has 3 multi-function digit input terminal(DI6~DI10).

Section V. Parameter Function Table

Code	Description/Display	Setting Range	Factory Setting	Change Limite
P4.00	DI1 terminal function selection	0-59	1	★
P4.01	DI2 terminal function selection	0-59	4	★
P4.02	DI3 terminal function selection	0-59	9	★
P4.03	DI4 terminal function selection	0-59	12	★
P4.04	DI5 terminal function selection	0-59	13	★
P4.05	DI6 terminal function selection	0-59	2	★
P4.06	DI7 terminal function selection	0-59	12	★
P4.07	DI8 terminal function selection	0-59	13	★
P4.08	DI9 terminal function selection	0-59	14	★
P4.09	DI10 terminal function selection	0-59	15	★

These parameters are used to set digital multi-function input terminals, as shown in the table below:

Setting	Function	Specification explanation
0	No- function	Set useless terminals to "no function", in order to prevent misoperation.
1	Forward command (FWD)	The forward jog and Reserved jog of the inverter are controlled via the external terminals.
2	Reserved command (REV)	
3	Three line running control	Set inverter running mode as three line control mode. For details please refer to function code P4.11(Terminal command mode).
4	FWD JOG command(FJOG)	FJOG refers to jog forward running, RJOG refers to jog Reserved running. For jog running frequency, jog acc./dec. time please refer to P8.00、P8.01、P8.02 for details.
5	REV JOG command(RJOG)	
6	Up command	When command source is set as "Digital Setup", the increase or decrease of the set frequency is implemented through the external terminal.
7	DOWN command	
8	Free stop	When this terminal command is valid, meaning that the inverter locks the output, the load will free stop according to the mechanical inertia. this way is the same with P6.10
9	Fault reset(RESET)	When this terminal command is valid, inverter's fault can be reset. It has the same function with RESET key on the keyboard. This function can realize remote fault reset.

Section V. Parameter Function Table

10	Operation suspended	Inverter decelerates to stop, but all operation parameters are memorized. E.g: PLC parameter, swing frequency parameter, PID parameter. When this terminal signal disappeared, inverter restored to running status as before.
11	External default normally open input	When the inverter detects that the signal occurs , it will report "15=Err15" fault, and handle the fault according to the fault protection action mode.(Please refer to P9.47 for details).
12	Multi-stage speed terminal1	The setting of 16-segment speeds can be realized by the combinations of the terminal status when the frequency source is "MS Speed". Refer to schedule 1 for details.
13	Multi-stage speed terminal2	
14	Multi-stage speed terminal3	
15	Multi-stage speed terminal4	
16	Acc./dec.time selection terminal 1	
17	Acc./dec.time selection terminal 2	
18	Frequency source switching	It is used to switch to choose different frequency sources. It realizes switching between 2 kinds of frequency sources according to the setup of P0.07.
19	UP/DOWN setup reset(terminal and keyboard)	When the frequency source is given as "Digital Setup" and the terminal command is valid, it can clear the frequency values changed through keyboard or terminals UP/DOWN and restore the reference frequency to the setup value of "Preset Frequency"(P0.08).
20	Running command switching terminal	When command source is set to terminal control (P0.02=1), the terminal could realize switching between terminal control and keyboard control. When command source is set to communication control(P0.02=2), the terminal could realize switching between communication control and keyboard control.
21	Acc./dec forbidden	When this terminal command is valid, it can maintain the current frequency output while stopping.
22	PID pause	PID temporary invalid, the inverter maintains the current frequency output and no longer taking PID adjustment of frequency source.
23	PLC status reset	When this terminal command is valid, it clears the memorized PLC running phase and running time, and

Section V. Parameter Function Table

		restores to the initial status of PLC running.
24	Swing frequency pause	When this terminal command is valid, the inverter maintains the frequency output of the swing frequency center, and the swing frequency pauses.
25	Counter input	It is used as input terminal of the counting pulse.
26	Counter reset	When this terminal command is valid, it clears the counting value of the counter to zero.
27	Length counting input	It is used as pulse input terminal of the length counting.
28	Length counting reset	When this terminal is valid, it clears the length counting to zero.
29	Torque control forbidden	It prohibits inverter torque control. Inverter enters in speed control mode.
30	PULSE frequency input(Only valid for DI5)	DI5 is used as pulse input terminal.
31	Reserved	Reserved
32	Immediate DC braking	When this terminal is valid, inverter directly switch to dc braking state.
33	External default normally closed input	When the inverter detects that the signal occurs , it will report "Err15" fault, and stop running.
34	Frequency modification enable	If the function is valid, inverter Yes not respond to frequency change until the function turns to be invalid.
35	PID direction Reservedd	PID and PA.03 set values are set in opposite directions when the terminal is valid.
36	External stop terminal1	It could make inverter stop when in keyboard control. Equivalent to function of STOP key on the keyboard.
37	Control command switching terminal 2	It is used to switch control mode between terminal and communication.
38	PID integration suspension	When it is valid, PID integration regulation function pauses, while PID proportional regulation and differential regulation function are still valid.
39	Frequency source X and preset frequency switching	When it is valid, frequency source X is replaced by the preset frequency P0.08.
40	Frequency source Y and preset frequency switching	When it is valid, frequency source Y is replaced by the preset frequency P0.08. .

Section V. Parameter Function Table

41	Motor selection terminal1	It can realize 4 groups of motor parameters switching by 4 combination status of this 2 terminals.For details please refer to schedule3.
42	Motor selection terminal2	
43	PID parameter switching	PA.18=1, the parameter is invalid, PID parameter takes use of PA.05~PA.07. On the contrary, PA.15~PA.17 are taken for the use.
44	User-defined fault 1	When user-defined fault 1&2 are valid, inverter alarm fault number 27= Err27 & 28= Err28 respectively. Inverter will handle the fault according to the mode selected by P9.49.
45	User-defined fault 2	
46	Speed control/ torque control switching	It enables control mode to switch between inverter torque control and speed control. Inverter running in the A0.00 defined mode when the terminal is invalid, and will switch to another mode when it is valid.
47	Emergency stop	Inverter stops at the fastest speed when the terminal is valid. Current is set to the current upper limit during this stop process. This function is used for inverter fast stop , which can meet the stop need in system emergency.
48	External stop terminal 2	This terminal can be used to stop the inverter in any circumstances (panel control ,terminal control and communication control). Deceleration time is fixed to deceleration time 4.
49	Deceleration DC braking	If it is valid, inverter first decelerates to stop DC braking start frequency and then switches to DC braking state.
50	Running time reset	Inverter running time of this time is cleared if the terminal is valid. It operates with the use of P8.42 and P8.53.
51	Two wire/three wire mode switcher	Two wire//three wire switcher
52	Reserved frequency forbidden	If it is valid,the inverter can not output Reserved frequency
53-59	Reserved	Reserved

Schedule 1 MS command function description

4 MS command terminals, which can be combined into 16 states. For 16 corresponding values, please refer to schedule 1 as below:

K4	K3	K2	K1	Command setup	Corresponding parameter
OFF	OFF	OFF	OFF	MS command 0	PC.00

Section V. Parameter Function Table

OFF	OFF	OFF	ON	MS command 1	PC.01
OFF	OFF	ON	OFF	MS command 2	PC.02
OFF	OFF	ON	ON	MS command 3	PC.03
OFF	ON	OFF	OFF	MS command 4	PC.04
OFF	ON	OFF	ON	MS command 5	PC.05
OFF	ON	ON	OFF	MS command 6	PC.06
OFF	ON	ON	ON	MS command 7	PC.07
ON	OFF	OFF	OFF	MS command 8	PC.08
ON	OFF	OFF	ON	MS command 9	PC.09
ON	OFF	ON	OFF	MS command 10	PC.10
ON	OFF	ON	ON	MS command 11	PC.11
ON	ON	OFF	OFF	MS command 12	PC.12
ON	ON	OFF	ON	MS command 13	PC.13
ON	ON	ON	OFF	MS command 14	PC.14
ON	ON	ON	ON	MS command 15	PC.15

When frequency source is set to multi-stage speed mode, 100.0% of function code PC.00~PC.15 are corresponding to maximum frequency P0.10. To meet the need, MS command can be used not only for multi-stage speed function, but also PID setup source or VF separation voltage source.

Schedule 2 Acceleration / deceleration terminal selection description:

Terminal2	Terminal1	Acc./dec. selection	Corresponding parameter
OFF	OFF	Acc./dec. time 1	P0.17、P0.18
OFF	ON	Acc./dec. time 2	P8.03、P8.04
ON	OFF	Acc./dec. time 3	P8.05、P8.06
ON	ON	Acc./dec. time 4	P8.07、P8.08

Schedule 3 Motor terminal selection description:

Section V. Parameter Function Table

Terminal2	Terminal1	Acc./dec. selection	Corresponding parameter
OFF	OFF	Motor 1	P1、 P2 group
OFF	ON	Motor 2	A2 group
ON	OFF	Motor 3	A3 group
ON	ON	Motor 4	A4 group

P4.10	DI filter time	0.000s~1.000s	0.010s	☆
-------	----------------	---------------	--------	---

If the digital input terminal malfunction because it is vulnerable to interference , users could increase the parameter value to enhance the interference immunity. However, this operation may cause reduced sensitivity of the DI terminal.

P4.11	Terminal command mode	1bit	Terminal input command mode	0	★	
		Two-line mode 1				0
		Two-line mode 2				1
		Three-line mode1				2
		Three-line mode2				3
		Two-line mode 3				4
		Three-line mode3				5
		10bit	Terminal input priority mode			
		JOG prior to run command FWD,REV				0
		run command FWD,REV prior to JOG				1

0 bit:

This parameter defines 6 different modes of controlling the forward and Reserved rotations of the inverter via the external terminal.

NOTE: In order to explain, The following arbitrary selection DI1~DI10 multifunctional input terminal DI1、DI2、DI3 three terminals as external terminals. That is, by setting the value of P4.00~P4.02 to select DI1、DI2、DI3 three terminal functions. Detailed function definition is P4.00~P4.09 setting range

Section V. Parameter Function Table

0: Two-line mode 1:

This mode is the most commonly used forward/Reserved rotation control mode. The forward/Reserved rotation of the motor is decided by the DI1, DI2 terminal commands. The descriptions on the terminal running command are as shown as below:

Terminal	Set value	Description
DI1	1	Forward(FWD)
DI2	2	Reserved(REV)

Among them ,DI1、 DI2 are DI1~DI10 multi-function input terminal, level valid.

0 invalid, 1 valid

K1	K2	Command
0	0	Stop
0	1	Reserved(REV)
1	0	Forward(FWD)
1	1	Stop

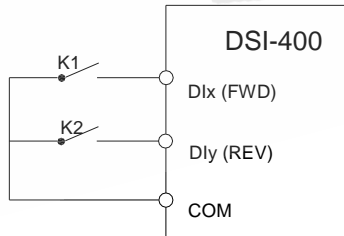

Fig. 5-6 Two-line control mode 1

1: Two-line mode 2:

In this operation mode, DI1 terminal function is to enable operation, while DI2 terminal function is to determine running direction. The descriptions on the terminal running command are as shown as below :

Terminal	Set value	Description
DI1	1	Forward(FWD)
DI2	2	Reserved(REV)

Among them , DI1、DI2 are DI1~DI10 multi-fuction input terminal, level valid

0 invalid, 1 valid

K1	K2	Command
0	0	Stop
0	1	Stop
1	0	Forward(FWD)
1	1	Reserved(REV)

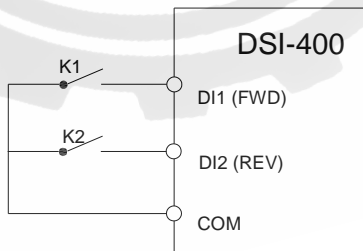

Fig. 5-7 Two-line control mode 2

2: Three-line mode1

In this operation mode, DI3 terminal is the enable terminal, running direction controlled by DI1 terminal、DI2terminal. The descriptions on the terminal running command are as shown as below:

Terminal	Set value	Description
DI1	1	Forward(FWD)
DI2	2	Reserved(REV)
DI3	3	Three-line running control

When in the need of running, users should first connect DI3 terminal. Forward and Reserved running is realized through the rising edge of Di1 or DI2.

When in the need of stop, user should disconnect DI3 terminal to meet the need. Among them, DI1、DI2、DI3 are multi-function input terminal of DI1~DI10. DI1,DI2 are of pulse valid, while DI3 level valid.

0 invalid. 1 valid. X arbitrarily

SB1	SB2	SB3	Command
0	X	X	Stop
1	1	0	Forward(FWD)
1	0	1	Reserved(REV)
1	1	0->1	Reserved(REV)
1	0->1	1	Forward(FWD)

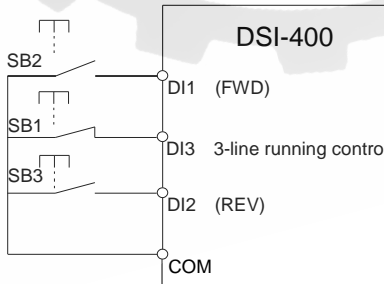

Fig. 5-8 Three-line control mode 1

Among them:

SB1: Stop button

SB2: Forward rotation button

SB3: Reserved rotation button

3: Three-line mode2

In this operation mode, DI3 terminal is the enable terminal, Direction by the state of the DI2 to decide, while DI1 terminal function is to determine running direction. The descriptions on the terminal running command are as shown as below:

Terminal	Set value	Description
DI1	1	Forward(FWD)
DI2	2	Reserved(REV)
DI3	3	Three-line running control

When in the need of running, users should first connect DI3 terminal. DI1 pulse rising edge gives running command signal, while DI2 status gives running direction signal.

When in the need of stop, user should disconnect DI3 terminal to meet the need. Among them, DI1, DI2, DI3 are multi-function input terminals of DI1~DI7. DI1 is of pulse valid, while DI2, DI3 is of level valid.

0 invalid. 1 valid. X arbitrarily

SB1	SB2	K	Command
0	X	X	Stop
1	1	0	Forward(FWD)
1	1	1	Reserved(REV)

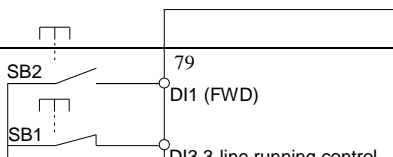

HYPER INVERTER

Fig. 5-9 Three-line control mode 2

Among them :

SB1: Stop button

SB2: Running button

4: Two-line mode3

this operation mode is Priority control two-line mode.The forward/Reserved rotation of the motor is decided by the DI1, DI2 terminal commands. The descriptions on the terminal running command are as shown as below:

Terminal	Set value	Description
DI1	1	Forward(FWD)
DI2	2	Reserved(REV)

Among them , DI1、DI2 are DI1~DI10 multi-fuction input terminal, level valid

0 invalid, 1valid

K1	K2	Command
0	0	Stop
0	1	Reserved(REV)
1	0	Forward(FWD)
1	0->1	Forward(FWD)

Section V. Parameter Function Table

0->1	1	Reserved(REV)
------	---	---------------

5: Three-line mode3

In this operation mode, DI3 terminal is the enable terminal, running direction controlled by DI1terminal、DI2terminal. The descriptions on the terminal running command are as shown as below:

Terminal	Set value	Description
DI1	1	Forward(FWD)
DI2	2	Reserved(REV)
DI3	3	Three-line running control

When in the need of running, users should first connect DI3 terminal. Forward and Reserved running is realized through the rising edge of DI1 or DI2

Direction as first control priority control, when DI1 is valid, DI2 pulse rising edge is invalid, when DI2 is valid, DI1 pulse rising edge is invalid, When in the need of stop, user should disconnect DI3 terminal to meet the need. Among them, DI1、DI2、DI3 are multi-function input terminal of DI1~DI7. DI1,DI2 are of pulse valid, while DI3 level valid.

0 invalid. 1 valid. X arbitrarily

SB1	SB2	SB3	Command
0	X	X	Stop
1	1	0	Forward(FWD)
1	0	1	Reserved(REV)
1	1	0->1	Forward(FWD)
1	0->1	1	Reserved(REV)

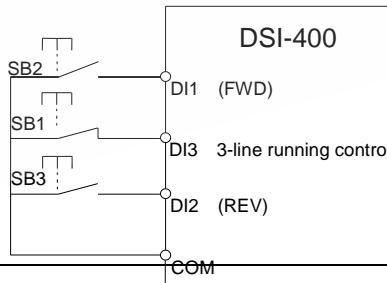

Section V. Parameter Function Table

Fig. 5-8 Three-line control mode 1

Among them:

SB1: Stop button

SB2: Forward rotation button

SB3: Reserved rotation button

P4.12	Terminal UP/DOWN variation rate	0.01Hz/s~65.535Hz/s	1.00Hz/s	☆
<p>It is used to set the frequency variation rate (frequency variation per second) when adjusting the set frequency with terminals UP/DOWN.</p> <p>When P0.22 (frequency decimal point) is set to 2, range of P4.12 value is 0.001Hz/s~65.535Hz/s.</p> <p>When P0.22 (frequency decimal point) is set to 1, range of P4.12 value is 0.01Hz/s~65.535Hz/s.</p>				
P4.13	AI curve 1 minimum input	0.00V~P4.15	0.00V	☆
P4.14	AI curve 1 minimum input corresponding setup	-100.00%~100.0%	0.0%	☆
P4.15	AI curve 1 maximum input	P4.13~10.00V	10.00V	☆
P4.16	AI curve 1 maximum input corresponding setup	-100.00%~100.0%	100.0%	☆
P4.17	AI1 filter time	0.00s~10.00s	0.10s	☆

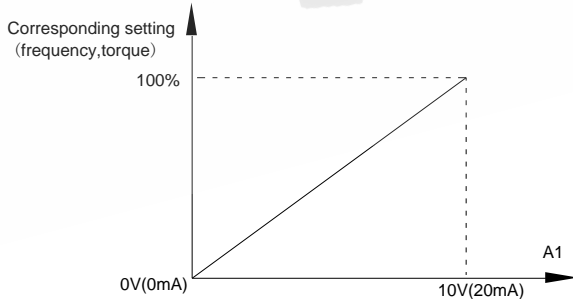

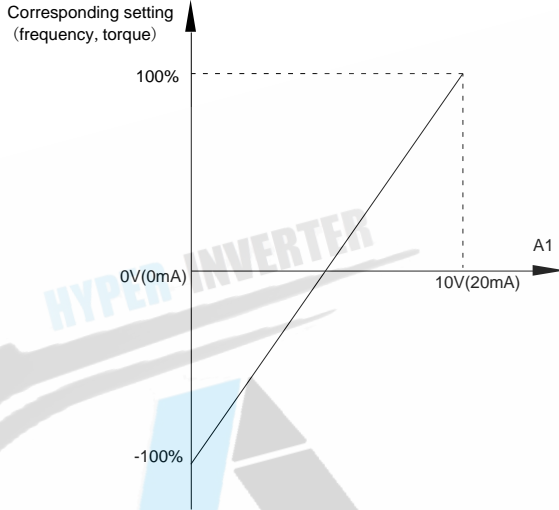

Fig. 5-10 Relationship between analog input and setup value

The parameters mentioned above define the relationship between analog input voltage and the analog input setup value.

When analog input voltage exceeds the setup "maximum input" limit, analog voltage is calculated as "maximum input". Similarly, when analog input is smaller than the setup "minimum input", analog voltage is calculated as minimum input or 0.0% according to the setting of P4.34.

AI used as current input terminal : 1mA current equals to 0.5V voltage.

AI input filtering time is used to set AI1 software filtering time. When field analog quantity is vulnerable, please increase the filtering time so that analog quantity tends to be stable. But excessive filtering time will lead to slow response time to analog detection. User should balance it according to practical application cases.

In various application cases, the nominal value corresponding to 100% of analog reference will be different. Refer to specific application description for the specific value.

Figure 5.10 shows typical setup cases.

P4.18	AI curve 2 minimum input	0.00V~P4.20	0.00V	☆
P4.19	AI curve 2 minimum input corresponding setup	-100.00%~100.0%	0.0%	☆
P4.20	AI curve 2 maximum input	P4.18~10.00V	10.00V	☆

Section V. Parameter Function Table

P4.21	AI curve 2 maximum input corresponding setup	-100.00%~100.0%	100.0%	☆		
P4.22	AI2 filter time	0.00s~10.00s	0.10s	☆		
For function and usage of curve 2, please refer to description of curve 1.						
P4.23	AI curve 3 minimum input	-10.00V~P4.25	-10V	☆		
P4.24	AI curve 3 minimum input corresponding setup	-100.00%~100.0%	0.0%	☆		
P4.25	AI curve3 maximum input	P4.23~10.00V	8.60V	☆		
P4.26	AI curve 3 maximum input corresponding setup	-100.00%~100.0%	100.0%	☆		
P4.27	AI3filter time	0.00s~10.00s	0.10s	☆		
For function and usage of curve 3, please refer to description of curve 1.						
P4.28	PULSE minimum input	0.00kHz~P4.30	0.00kHz	☆		
P4.29	PULSE minimum input corresponding setup	-100.00%~100.0%	0.0%	☆		
P4.30	PULSE maximum input	P4.28~50.00kHz	50.00kHz	☆		
P4.31	PULSE maximum input corresponding setup	-100.00%~100.0%	100.0%	☆		
P4.32	PULSE filter time	0.00s~10.00s	0.10s	☆		
<p>This group of parameters are used to set relationship between DI5 pulse frequency and it's corresponding settings.</p> <p>Pulse frequency can be only input to the inverter through DI5 channel. This function group's applications are similar to curve 1,please refer to the description of curve 1.</p>						
P4.33	AI curve selection	1bit	AI1 curve selection		321	☆
		Curve1(2 points, see P4.13~P4.16)		1		
		Curve2(2 points, see P4.18~P4.21)		2		
		Curve3(2 points, see P4.23~P4.26)		3		
		Curve4(4 points, see A6.00~A6.07)		4		
		Curve5(4 points, see A6.08~A6.15)		5		
		10bit	AI2 curve selection			
		Curve1(2 points, see P4.13~P4.16)		1		
		Curve2(2 points, see P4.18~P4.21)		2		

Section V. Parameter Function Table

		Curve3(2 points, see P4.23~P4.26)	3			
		Curve4(4 points, see A6.00~A6.07)	4			
		Curve5(4 points, see A6.00~A6.07)	5			
		100bit	AI3 curve selection			
		Curve1(2 points, see P4.13~P4.16)	1			
		Curve2(2 points, see P4.18~P4.21)	2			
		Curve3(2 points, see P4.23~P4.26)	3			
		Curve4(4 points, see A6.00~A6.07)	4			
		Curve5(4 points, see A6.00~A6.07)	5			

The 1bit, 10bit, 100bit of the function code are used to choose the set curve of analog input AI1、AI2、AI3 respectively.

3 analog input can choose any curve of the 5 types.

Curve1, curve 2, curve 3 are 2 points curve that set through P4 group function codes, while curve 4, curve 5 are 4 points curve that set through A8 group function codes.

DSI-400 standard unit offers 3-channel analog input terminals. Multi-function I/O expansion card is needed in the use of AI3x.

P4.34	AI below minimum input setup selection	1bit	AI1 below minimum input setup selection		000	☆
		Minimum input setup		0		
		0.0%		1		
		10bit	AI2 below minimum input setup selection			
		Minimum input setup		0		
		0.0%		1		
		100bit	AI3 below minimum input set selection			
		Minimum input setup		0		
		0.0%		1		

This function code is used to determine analog quantity corresponding setup when analog input voltage

Section V. Parameter Function Table

below the setup of minimum input.					
<p>The 1bit, 10bit, 100bit of the function code are corresponding to the analog input AI1、AI2、AI3 respectively. If the bit is set to 0 and AI is below the minimum setup, the analog input setup is the curve "minimum input corresponding setup"(P4.14、P4.19、P4.24). If the bit is set to 0 and AI is below the minimum setup, the analog quantity corresponding setup is 0.0%.</p>					
P4.35	DI1 delay time	0.0s~3600.0s		0.0s ★	
P4.36	DI2 delay time	0.0s~3600.0s		0.0s ★	
P4.37	DI3 delay time	0.0s~3600.0s		0.0s ★	
<p>Only DI1, DI2, DI3 are able to set equipment delay time.</p> <p>They are used to set delay time to inverter DI terminal state change.</p>					
P4.38	DI terminal effective mode selection 1	1bit	DI1 terminal valid state setup		00000 ★
		High level valid		0	
		Low level valid		1	
		10bit	DI2 terminal valid state setup		
		High level valid		0	
		Low level valid		1	
		100bit	DI3 terminal valid state setup		
		High level valid		0	
		Low level valid		1	
		1000 bit	DI4 terminal valid state setup		
		High level valid		0	
		Low level valid		1	
		1000 0bit	DI5 terminal valid state setup		
		High level valid		0	
Low level valid		1			
P4.39	DI terminal effective mode selection 2	1bit	DI6 terminal valid state setup		00000 ★
		High level valid		0	

Section V. Parameter Function Table

		Low level valid	1		
		10bit	DI7 terminal valid state setup		
		High level valid	0		
		Low level valid	1		
		100bit	DI8 terminal valid state setup		
		High level valid	0		
		Low level valid	1		
		1000bit	DI9 terminal valid state setup		
		High level valid	0		
		Low level valid	1		
		1000Obit	DI10 terminal valid state setup		
		High level valid	0		
		Low level valid	1		
<p>It is used to set digital input terminal effective mode.</p> <p>High level valid: Connection between COM and corresponding DI is valid, disconnection invalid.</p> <p>Low level valid: Connection between COM and corresponding DI is invalid, disconnection valid.</p>					

5-7 Output terminal: P5.00-P5.22

DSI-400 series inverter provides two multifunctional analog terminal output selections, two multifunctional relay output terminal, two DO terminal (FM can be used as high speed pulse output terminal as well as open collector switching output).

Code	Description/ Keyboard Display	Setting Range		Factory Setting	Change Limite
P5.00	FM terminal output mode selection	Pulse output(FMP)	0	1	☆
		Switch output(FMR)	1		
<p>Y1 is programmable multiplex terminal, which can be used as high speed pulse output terminal (FMP) or open collector switching output terminal (FMR).</p>					

Section V. Parameter Function Table

When P5.00 is set to 0, maximum output frequency can reach 10kHz , please refer to P5.06 for related description.

P5.01	FMRselection (open collector output terminal)	0-41	0	☆
P5.02	Relay output selection (TA1.TB1.TC1)	0-41	2	☆
P5.03	Relay output selection (TA2.TB2.TC2)	0-41	0	☆
P5.04	DO1 output selection(open collector output terminal)	0-41	0	☆
P5.05	DO2 output selection	0-41	4	☆

The above 5 function codes are used to select 5 digital output function. TA1.TB1.TC1 and TA2.TB2.TC2 are control board and expansion card relay respectively.

Function selections are as follows:

Set value	Function	Description
0	No output	The output terminals have no function
1	Inverter in operation	When the inverter is running, ON signal is output.
2	Output fault(Stop fault)	When inverter fault happens and stops due to the fault , ON signal is output
3	Frequency level detection FDT1 output	Refer to P8.19 and P8.20 function codes for details
4	Frequency arrival	Refer to P8.21 function codes for details
5	Null speed operation(stop without output)	When inverter is in running status and output 0Hz , ON signal is output. When inverter is in stop status, OFF signal is output.
6	Motor overload pre-alarm	Judgment will be made according to the pre-alarm parameter value before the motor electronic thermal protection is enabled. If it exceeds the pre-alarm parameter value, ON signal will be output. Refer to P9.00 to P9.02 function codes for the descriptions of motor overload.
7	Inverter overload pre-alarm	When it is found that the inverter is overloaded, ON signal will be output before the overload protection occurs.

Section V. Parameter Function Table

8	Setup counting value arrived	When the counting value reaches the value of PB.08, it outputs ON signal.
9	Designated counting value arrived	When the counting value reaches the value of PB.09, it outputs ON signal.Refers to PB group for details.
10	Length arrived	When the actual length exceeds the setup value in PB.05, it outputs ON signal.
11	PLC circulation end	When the simple PLC running finishes one circulation, it outputs a pulse signal with width of 250ms.
12	Total running time arrived	When the accumulated running time of the inverter exceeds the setup time (P8.17), it outputs ON signal.
13	Frequency limit	When set frequency exceeds upper limit frequency or lower limit frequency,and inverter output frequency exceeds upper limit frequency or lower limit frequency, it outputs ON signal.
14	Torque limit	In speed control mode, if output torque reaches the torque limit, inverter will be in stall protection status and output ON signal.
15	RUN ready	When the inverter has no fault and the bus voltage works normally and the inverter is ready for running, it outputs ON signal. Upon normal startup, it closes the output.
16	AI1>AI2	When the voltage value of analog input AI1 is bigger than that of analog input AI2, it output ON signal.
17	Frequency upper limit arrived	When the running frequency of the inverter reaches the frequency upper limit, it outputs ON signal.
18	Frequency lower limit arrived (stop without output)	When the running frequency of the inverter reaches the frequency lower limit, it outputs ON signal.And output OFF signal in stop status.
19	Under voltage state output	When inverter is in under voltage status, it outputs ON signal.
20	Communication setup	Please refer to communication protocol.
21	Reserved	Reserved
22	Reserved	Reserved
23	Null speed operation 2(Stop with output)	When inverter output 0Hz , ON signal is output. When inverter is in stop status, ON signal is output.
24	Total power-on time arrival	When accumulated power-on time(P7.13) exceeds

Section V. Parameter Function Table

		P8.16 set value, it outputs ON signal.		
25	Inspection level of FDT2 frequency	Please refer to function code P8.28、 P8.29 for details.		
26	Frequency 1 arrival output	Please refer to function code P8.30、 P8.31 for details.		
27	Frequency 2 arrival output	Please refer to function code P8.32、 P8.33 for details.		
28	Current 1 arrival output	Please refer to function code P8.38、 P8.39 for details.		
29	Current 2 arrival output	Please refer to function code P8.40、 P8.41 for details.		
30	Timing arrival output	When inverter running time reaches the set timing (P8.42 valid), it outputs ON signal.		
31	A11excessive input	When analog input value A11 is bigger than P8.46 (A11 input protection upper limit) or smaller than P8.45(A11 input protection lower limit), it output ON signal.		
32	Load off	Inverter in load off status, it output ON signal.		
33	Reserved running	Inverter in Reserved running mode, it outputs ON signal.		
34	Zero current state	Please refer to function code P8.28、 P8.29 for details.		
35	Module temperature arrival	When module radiator temperature(P7.07) reaches the set value of P8.47, it outputs ON signal.		
36	Software excessive current	Please refer to function code P8.36、 P8.37 for details.		
37	Frequency lower limit arrival(stop with output)	When running frequency reaches frequency lower limit, it outputs ON signal.When in stop status ,it outputs ON signal too.		
38	Alarm output	When inverter fault with processing mode of continue running, it outputs alarm signal.		
39	Motor over temperature alarm	When motor temperature reaches set value of P9.58 , it outputs ON signal.(temperature can be viewed through U0.34)		
40	The running time arrival	When the running time exceeds the set value of P8.53 , it outputs ON signal.		
41	Alarm output	When inverter fault with processing mode of continue running(uninclude under voltage fault), it outputs alarm signal.		
P5.06	FMP output function selection(pulse output	0-16	0	☆

Section V. Parameter Function Table

	terminal)			
P5.07	AO1 output function selection	0-16	0	☆
P5.08	AO2 output function selection	0-16	1	☆
<p>FMP terminal output pulse frequency range: 0.01kHz~P5.09(FMP maximum frequency output), P5.09 could vary from 0.01kHz to 100.00kHz.</p> <p>AO1, AO2 output ranges from 0V to 10V, or 0mA to 20mA.</p> <p>The corresponding value range is shown in the table below:</p>				
Setup value	Function	Range		
0	Running frequency	0~maximum output frequency		
1	Setup frequency	0~maximum output frequency		
2	Output current	0~200%ofthe rated current of the inverter		
3	Output torque	0~200% of the rated torque of the inverter		
4	Output power	0~200% of the rated power of the inverter		
5	Output voltage	0~120% of the rated voltage of the inverter		
6	PULSE input	0.01kHz~100.00kHz		
7	AI1	0V~10V		
8	AI2	0V~10V(Or 0~20mA)		
9	AI3	0V~10V		
10	Length	0~Maximum length		
11	Counting value	0~Maximum counting value		
12	Communication setup	0.0%~100.0%		
13	Motor revolving speed	0~maximum output frequency corresponding speed		
14	Output current	0.0A~1000.0A		
15	Output voltage	0.0V~1000.0V		
16	Output torque	Actual value, proportion to motor torque		
P5.09	FMP maximum output frequency	0.01kHz~100.00kHz	50.00kHz	☆

Section V. Parameter Function Table

When the multifunctional terminal output function selects FMP pulse output, it can set the maximum frequency value of output pulse.						
P5.10	AO1 zero offset	-100.0%~+100.0%	0.0%	☆		
P5.11	AO1 gain	-10.00~+10.00	1.00	☆		
P5.12	Expansion card AO2zero offset	-100.0%~+100.0%	0.00%	☆		
P5.13	Expansion card AO2 gain	-10.00~+10.00	1.00	☆		
<p>Function codes above are generally used to modify the zero drift of the analog output and also be used to define required AO output curves.</p> <p>If b represents zero offset, k represents gain, Y represents actual output, and X represents standard output, the actual output is calculated as follows: $Y=kX+b$</p> <p>AO1, AO2 zero offset coefficient 100% corresponds to 10V (20mA).</p> <p>For example, if the analog output is the running frequency, and it is expected to output 8V (16mA) when the frequency is 0, and output 3V (6mA) at the maximum frequency, the standard output 0V to 10V shall be modified to 8V to 3V output. As per the above formula, AO zero offset coefficient shall be set to "80%", while AO gain shall be set to "-0.50".</p>						
P5.17	FMR output delay time	0.0s~3600.0s	0.0s	☆		
P5.18	RELAY1 output delay time	0.0s~3600.0s	0.0s	☆		
P5.19	RELAY2 output delay time	0.0s~3600.0s	0.0s	☆		
P5.20	DO1 output delay time	0.0s~3600.0s	0.0s	☆		
P5.21	DO2 output delay time	0.0s~3600.0s	0.0s	☆		
Set output terminal FMR, relay 1, relay 2, DO1 and DO2 delay time that begins from status changing to real output changing.						
P5.22	DO output terminal valid state selection	1bit	FMR valid state selection		00000	☆
		Positive logic		0		
		Negative logic		1		
		10bit	RELAY1 terminal valid state setup			
		Positive logic		0		
		Negative logic		1		
100bit	RELAY2 terminal valid state setup					

Section V. Parameter Function Table

		Positive logic		0			
		Negative logic		1			
		1000 bit	DO1 terminal valid state setup				
		Positive logic		0			
		Negative logic		1			
		10000 bit	DO2 terminal valid state setup				
		Positive logic		0			
		Negative logic		1			
<p>Define output terminal FMR、Relay 1、Relay 2、DO1 andDO2 output logic.</p> <p>0: Positive logic</p> <p>Digital output terminals and the corresponding public end connected as effective state, disconnect for invalid state.</p> <p>1: Negative logic</p> <p>Digital output terminals and the corresponding public end connected as invalid state, disconnect for effective state.</p>							

5-8 Start/stop control: P6.00-P6.25

Code	Description/ Keyboard Display	Setting Range		Factory Setting	Change Limite
P6.00	Start mode	Direct startup	0	0	☆
		Revolving speed tracking startup	1		
		Pre-excitation startup (AC asynchronous motor)	2		
		SVC quick start	3		

Section V. Parameter Function Table

<p>0: Direct startup:</p> <p>When the DC brake time is zero, it starts at the startup frequency.</p> <p>When the DC brake time is non-zero value, it can perform DC brake before start. It is suitable for the applications where small inertia may cause Reserved rotation at the time of startup.</p> <p>1: Revolving speed tracking startup:</p> <p>The inverter firstly judges the revolving speed and direction of the motor and then starts at the frequency corresponding to the tracked rotation velocity of the motor, and performs smooth startup of the motor in rotation without impact. It is suitable for the applications where large inertia is restarted due to transient power shutdown. In order to ensure the performance of the rotation velocity tracking startup, motor parameters (Group P1) should be set correctly.</p> <p>2: Asynchronous pre-excitation startup</p> <p>It is only valid for asynchronous motor, and is used to establish magnetic field before motor operation. For pre-excitation current, pre-excitation time please refer to function code P6.05 and P6.06.</p> <p>If pre-excitation time is set to 0, the pre-excitation process will be canceled, and start with start frequency. If pre-excitation time is not set to 0, inverter first pre-excitation then startup. In this way, motor dynamic response performance is promoted.</p> <p>3. Svc quick start</p> <p>This mode only used in svc control of asynchronous motor. It can reduce the start time.</p>					
P6.01	Revolving speed tracking mode	Start from stop frequency	0	0	★
		Start from zero speed	1		
		Start from maximum frequency	2		
<p>In order to complete the rotation speed tracking process in the shortest period, it can select the mode of inverter tracking the rotation velocity of motor:</p> <p>0: Track downward from the frequency at the time of stop, which is generally selected at first.</p> <p>1: Track upward from zero frequency, which is used when the inverter is restarted upon long period of power shutdown</p> <p>2: Track downward from the maximum frequency, which is generally used for power generating load.</p>					
P6.02	Revolving speed tracking speed	1~100	20	☆	
<p>In the mode of revolving speed tracking startup, it is used to select the speed of rotation tracking. The higher the parameter value is, the faster the tracking velocity is, but too higher value may cause unreliable tracking.</p>					
P6.03	Start frequency	0.00Hz~10.00Hz	0.00Hz	☆	

Section V. Parameter Function Table

P6.04	Start frequency holding time	0.0s~100.0s	0.0s	★
<p>To ensure the torque at the time of startup, proper startup frequency shall be set. In addition, in order to set up magnetic flux when waiting for the startup of the motor, the startup frequency shall remain for a certain period of time before accelerating to the setup frequency.</p> <p>Start frequency P6.03 is not affected by the lower frequency limit.If the frequency reference value (frequency source) is lower than the startup frequency, the inverter cannot start and will be in standby status.</p> <p>In positive&negative switching process, startup frequency retention time Yes not work.Startup frequency retention time is not included in the acceleration time,but included in the simple PLC running time.</p> <p>Example 1:</p> <p>P0.03=0 means the frequency source is digital reference.</p> <p>P0.08=2.00Hz means the digital setup frequency is 2.00Hz.</p> <p>P6.03=5.00Hz means the startup frequency is 5.00Hz.</p> <p>P6.04=2.0s means that the startup frequency retention time is 2.0s.</p> <p>In this case, the inverter will be in the standby status and its output frequency is 0Hz.</p> <p>Example 2:</p> <p>P0.03=0 means the frequency source is digital reference.</p> <p>P0.08=10.00Hz means the digital setup frequency is 10.00Hz.</p> <p>P6.03=5.00Hz means the startup frequency is 5.00Hz.</p> <p>P6.04=2.0s means that the startup frequency retention time is 2.0s.</p> <p>In this case, the inverter accelerates to 5.00 Hz and remains for 2 seconds, and then accelerates to the setup frequency 10Hz.</p>				
P6.05	Start dc braking current /pre-excitation current	0%~100%	0%	★
P6.06	Start dc braking time /pre-excitation time	0.0s~100.0s	0.0s	★
<p>Pre-excitation is used to establish asynchronous motor magnetic field before startup, which would improve response speed.</p> <p>Start dc current braking is only valid when it is direct startup. Inverter first carries out dc braking according to the setup of start dc current braking , and then carries out operation after start dc braking time.</p> <p>If dc braking time is set to 0, inverter directly start without dc braking. The bigger the dc braking current is , the greater the braking force is.</p> <p>If start mode is asynchronous motor pre-excitation start, inverter first establish magnetic field through pre-excitation current setup, then start to run after pre-excitation time. If set pre-excitation time to 0, inverter</p>				

Section V. Parameter Function Table

would directly start without pre-excitation process./				
Start dc braking current/pre-excitation current is the relative percentage of rated current.				
P6.07	Acceleration/ deceleration mode	Straight acc./dec.	0	0 ★
		S curve acc./dec. mode A	1	
<p>It is used to select the frequency change mode during the inverter start and stop process.</p> <p>0: Straight acceleration/ deceleration</p> <p>The output frequency increases or decreases along the straight line. DSI-400 series inverter provides 4 types of acceleration/deceleration time.It can select acceleration/ deceleration time via the multifunctional digital input terminals.</p> <p>1: S-curve acceleration/ deceleration mode A</p> <p>The output frequency increases or decreases along the straight line. S curve is generally used in the applications where start and stop processes are relatively gentle, such as elevator and conveyor belt.The acceleration/ deceleration time is consistent with the straight acceleration/ deceleration time.Function codes of P6.08 and P6.09 can be respectively definedthe time proportion of starting-segment and finishing-segment for S-curve acceleration/ deceleration.</p>				
P6.08	Initial-segment time proportion of S-curve	0.0%~(100.0%.P6.09)	30.0%	★
P6.09	Finishing-segment time proportion of S-curve	0.0%~(100.0%.P6.08)	30.0%	★
<p>Function code of P6.08 and P6.09 can be respectively defined the time proportion between the S-curve initial-segment and finishing-segment for S-curve acceleration/ deceleration A. They are required to meet the standard of $P6.08+P6.09 \leq 100.0\%$.</p> <p>t1 in the Fig.5-11 is the parameters defined by P6.08, in this period of time which the changing slope of output frequency is becoming larger and larger. t2 is defined by parameter P6.09, in this period of time which the changing slope of output frequency change to zero. The changing slope of output frequency is fixing within the time of t1 and t2.</p>				

Section V. Parameter Function Table

Fig.5-11S-curve acceleration/deceleration schematic diagram A					
P6.10	Stop mode	Speed-down to stop	0	0	☆
		Free stop	1		
<p>0 : Deceleration to stop</p> <p>When the stop command is valid, the inverter will decelerate to stop according to the setup deceleration time.</p> <p>1 : Free stop</p> <p>When the stop command is valid, the inverter will terminate the output immediately and the load will coast to stop according to the mechanical inertia.</p>					
P6.11	DC braking initial frequency at stop	0.00Hz~maximum frequency	0.00Hz	☆	
P6.12	DC braking waiting time at stop	0.0s~36.0s	0.0s	☆	
P6.13	DC braking current at stop	0%~100%	0%	☆	
P6.14	DC braking time at stop	0.0s~100.0s	0.0s	☆	
<p>DC brake initial frequency at stop: During the process of decelerating to stop, when the running frequency at stop reaches this frequency, it will start the process of DC brake.</p> <p>DC brake waiting time at stop: Prior to the beginning of DC brake at stop, the inverter will terminate the output, and then start DC brake after this delay time. It is used to prevent over current fault due to DC brake which starts at the time of higher velocity.</p> <p>DC brake current at stop: The DC brake quantity added shall be set according to the percentage setting of the rated current of the inverter. The higher the brake current is, more powerful the brake effect is.</p> <p>DC brake time at stop: It refers to the continuous DC brake time. If this DC brake time is set to 0, it indicates that there is no DC brake process, and the inverter will stop according to the setting process of decelerating to stop.</p> <p>The process of DC brake at stop is as shown in Figure below.</p>					

Section V. Parameter Function Table

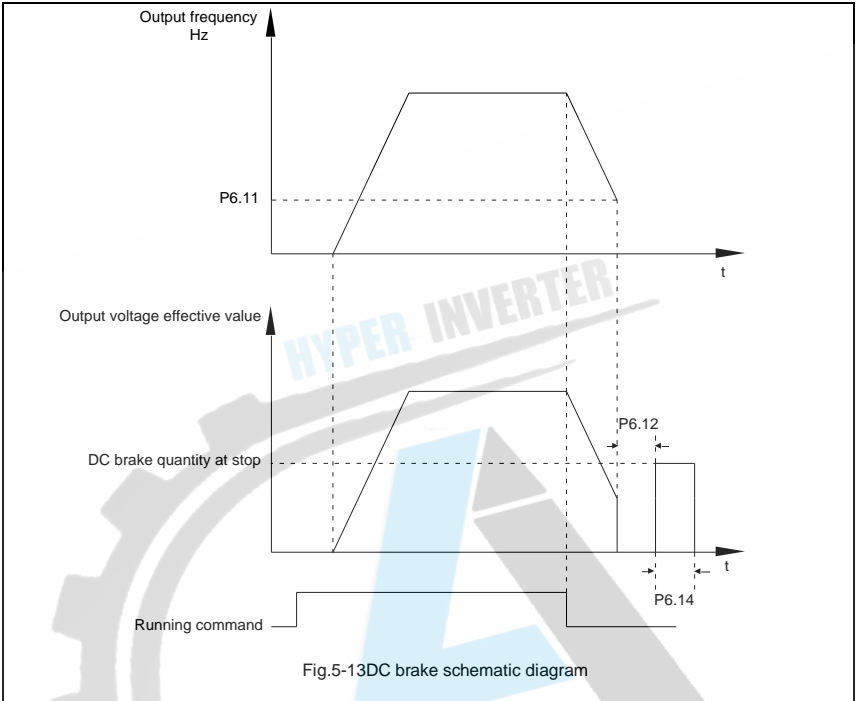

P6.15	Brake utilization ratio	0%~100%		100%	☆
<p>It is only valid for the inverter with built-in brake unit.</p> <p>It is used to adjust the duty ratio of the brake unit. When the brake utilization ratio is high, then the duty ratio of brake unit action is high, braking effect is strong. But there will be big fluctuation of inverter bus voltage.</p>					
P6.18	Catching a spinning motor current limit	30%~200%		Model dependent	★
P6.21	Demagnetization time for svc	0.00-5.00s		Model dependent	☆
P6.23	Over excitation selection	Disable	0	0	☆
		Enable during deceleration	1		
		Enable in whole process	2		
P6.24	Over excitation suppression current gain	0-150%		Model dependent	☆
P6.25	Over excitation gain	1.00-2.50		1.25	☆

5-9 Keyboard and display: P7.00-P7.14

Code	Description/ Keyboard Display	Setting Range		Factory Setting	Change Limit
P7.01	MF/REV key function selection	MF/REV key invalid	0	0	★
		Switching between operation panel command channel&the remote command channel (terminal command channel or serial port command channel)	1		
		Switching between FWD&REV rotation	2		
		Forward jog command	3		
		Reserved jog command	4		
		<p>It is used to set the functions of multifunctional MF/REV key.</p> <p>0: Invalid function</p> <p>1: Operation panel command channel and remote command channel</p> <p>It can perform switching between the current command source and keyboard control(local operation).The function key is invalid when current command source is keyboard control.</p> <p>2: Switching between forward and Reserved rotation</p> <p>Switching the rotary direction of the motor via the MF/REV key on the keyboard is only enabled when the command source is "operation panel command".</p> <p>3: Forward jog</p> <p>It can perform forward jog (FJOG) operation via the MF/REV key on the keyboard.</p> <p>4: Reserved jog</p> <p>It can perform Reserved jog (RJOG) operation via the MF/REV key on the keyboard.</p>			
P7.02	STOP/RESET function	The stop function of STOP/RES key is valid only in the keyboard control mode.	0	1	☆
		The stop function of STOP/RES key is valid in any control mode.	1		
P7.03	LED running display parameter1	0000~FFFF		1F	☆

Section V. Parameter Function Table

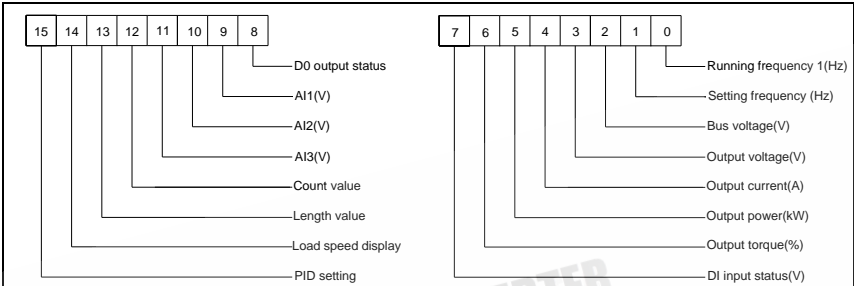

If the above parameters need to be displayed during the operation, users can set their corresponding positions to 1 and then convert this binary number into decimal number and set it to P7.03.

P7.04	LED running display parameter 2	0000~FFFF	0	☆
-------	---------------------------------	-----------	---	---

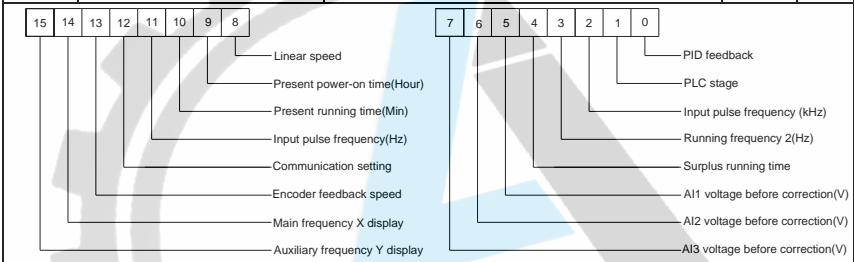

If the above parameters need to be displayed during the operation, users can set their corresponding positions to 1 and then convert this binary number into decimal number and set it to P7.04.

Running display parameter is used to set parameters which can be seen under inverter running state.

32 state parameters can be checked at most, you could choose the needed state parameter through P7.03、P7.04 binary digit, display sequence starts from P7.03 lowest digit order.

P7.05	LED stop display parameter	0000~FFFF	33	☆
-------	----------------------------	-----------	----	---

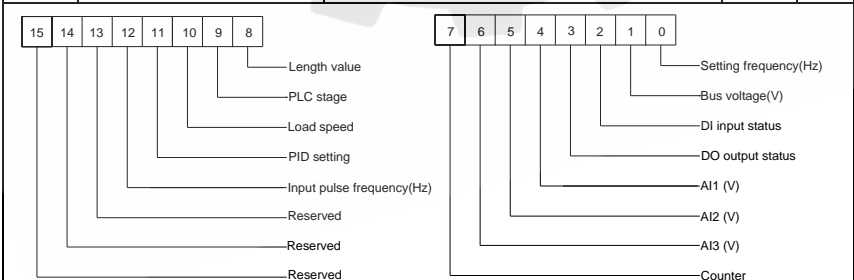

If the above parameters need to be displayed at the time of stop, it can set their corresponding positions

Section V. Parameter Function Table

to 1 and then convert this binary number into decimal number and set it to P7.05.				
P7.06	Load speed coefficient	0.0001~6.5000	1.0000	☆
When display of the load speed is necessary, P7.06 is used to adjust the corresponding relationship between inverter frequency output and load speed. For details please refer to P7.12.				
P7.07	Inverter module radiator temperature	0.0℃~100.0℃	12℃	•
It is used to display IGBT temperature. Different model's inverter module is set with different IGBT over temperature protection value.				
P7.08	Product ID		0℃	•
Display inverter product ID				
P7.09	Accumulative running time	0h~65535h	0h	•
It is used to display the accumulated running time of the inverter. When the accumulated running time reaches P8.17 setup running time, the multifunctional digital output terminal(12) will output ON signal.				
P7.10	Performance version number	Display performance version number	-	•
P7.11	Software version No.	Control board software version No.	-	•
P7.12	Load speed display decimal digits	No decimal place	0	1 ☆
		One decimal place	1	
		Two decimal places	2	
		Three decimal places	3	
Decimal point position: It is used to set the number of decimal places of the load speed. For example, if the Load speed display coefficient P7.06 is 2.000,load speed display decimal digits is 2(Two decimal places),when inverter running frequency is 40.00Hz,the load speed will be : $40.00 \times 2.000 = 80.00$ (2 decimal digit display) If the inverter is in stopped state, then load speed displays as corresponding set frequency speed.Take set frequency of 50.00Hz as an example,the stop state load speed is: $50.00 \times 2.000 = 100.00$ (Two decimal places)				
P7.13	Accumulative power-on time	0h~65535h	-	•
It displays accumulative power-on time since leaving the factory. When it reaches the set power-on time (P8.17) , multi-function digital output (24) ON signal.				
P7.14	Accumulative power	0~65535	-	•

Section V. Parameter Function Table

	consumption			
It displays the inverter accumulative power consumption.				

5-10 Auxiliary function: P8.00-P8.53

Code	Description/ Keyboard Display	Setting Range	Factory Setting	Change Limit
P8.00	Jog running frequency	0.00Hz~maximum frequency	2.00Hz	☆
P8.01	Jog acceleration time	0.0s~6500.0s	20.0s	☆
P8.02	Jog deceleration time	0.0s~6500.0s	20.0s	☆
<p>It defines the reference frequency and acc. / dec. time of the inverter at the time of jogging.</p> <p>The jog process is started and stopped according to direct startup mode(P6.00=0)and decelerate to stop mode(P6.10=0).</p>				
P8.03	Acceleration time 2	0.0s~6500.0s	10.0s	☆
P8.04	Deceleration time 2	0.0s~6500.0s	10.0s	☆
P8.05	Acceleration time 3	0.0s~6500.0s	10.0s	☆
P8.06	Deceleration time 3	0.0s~6500.0s	10.0s	☆
P8.07	Acceleration time 4	0.0s~6500.0s	10.0s	☆
P8.08	Deceleration time 4	0.0s~6500.0s	10.0s	☆
<p>DSI-400 offers 4 groups of speed-up/speed-down time,P0.17/P0.18 and 3 groups above.</p> <p>P8.03 to P8.08 parameters have the same definition with P0.17 and P0.18.You can switch to choose the 4 groups through different combination of DI multi-function digital input terminal.For specific using method,please refer to function code P4.01~P4.05 for details.</p>				
P8.09	Hopping frequency 1	0.00Hz~maximum frequency	0.00Hz	☆
P8.10	Hopping frequency 2	0.00Hz~maximum frequency	0.00Hz	☆
P8.11	Hopping frequency amplitude	0.00Hz~maximum frequency	0.00Hz	☆

Section V. Parameter Function Table

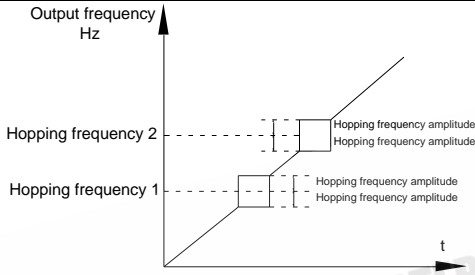

Fig.5-14 Skip frequency schematic diagram

When set frequency is within the range of hopping frequency, the actual running frequency will run close to the set frequency of hopping frequency. Inverter can avoid load mechanical resonance by setting hopping frequency.

DSI-400 can set 2 hopping frequency points, if both of them are set to 0, then the hopping frequency function is canceled. Hopping frequency and hopping frequency amplitude schematic is shown in Fig-5-14.

P8.12	Dead zone time of forward&Reserved rotations	0.00s~3000.0s	0.0s	☆
-------	--	---------------	------	---

It refers to the transit time at the 0Hz output point when the inverter switches between forward rotation and Reserved rotation. As shown in figure 5-15.

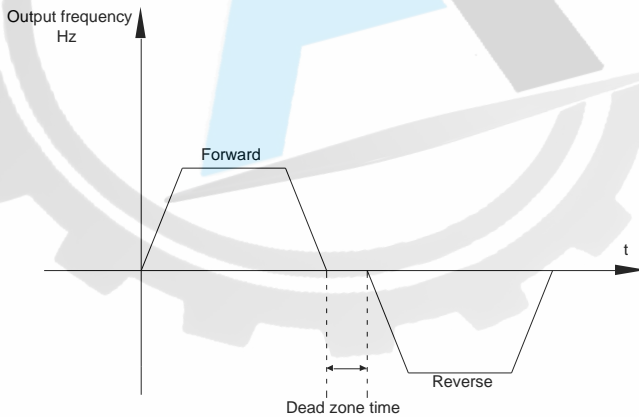

Fig.5-15 Rotation dead zone time schematic diagram

P8.13	Reserved rotation control	Reserved rotation enabled	0	0	☆
		Reserved rotation forbidden	1		

It is used to set if the inverter could run in Reserved rotation state. If Reserved rotation is not permitted, P8.13 should be set to 1.

Section V. Parameter Function Table

P8.14	Set frequency below lower limit running mode	Run with frequency lower limit	0	0	☆
		stop	1		
		0 speed operation	2		
It is used to select the running status of the inverter when the set frequency is lower than the frequency lower limit. DSI-400 offers 3 kinds of running mode to meet all kinds of applications.					
P8.15	Droop control	0.00Hz~10.00Hz		0.00Hz	☆
<p>It is used for load distribution when multiple motors drive the same load.</p> <p>Droop control refers to inverter output frequency decreasing with added load. In this way, motor with heavy load output frequency decrease more, which could decrease the motor load to realize multiple motor load uniformity .</p> <p>This parameter is the output frequency declining value with rated output load.</p>					
P8.16	Accumulative power-on time arrival setup	0h~65000h		0h	☆
<p>When the accumulative power on time (P7.13) reaches the P8.16 set value, inverter multi-function digital DO would output ON signal.</p> <p>E.g: Inverter outputs fault alarm after 100-hour power-on time:</p> <p>Virtual terminal DI1 function: user-defined fault1: A1.00=44;</p> <p>Virtual terminal DI1 valid state: from virtual DO1: A1.05=0000;</p> <p>Virtual terminal DO1 function: power-on time arrived : A1.11=24;</p> <p>Set cumulative power-on time to 100 hours: P8.16=100.</p> <p>When accumulative power-on time reaches 100 hours, inverter outputs fault number 26= E.ArA.</p>					
P8.17	Accumulative running time arrival setup	0h~65000h		0h	☆
<p>When the accumulated running time (P7.09) reaches this set running time, the digital output terminal DO outputs the ON signal of running time arrival.</p>					
P8.18	Start protection selection	Invalid	0	0	☆
		Valid	1		
<p>This parameter is used to improve the safety protection coefficient.</p> <p>If it is set to 1, it has two functions:</p> <p>1.If running command is valid upon power on (E.g: Closed-state before terminal running command power on), inverter will not respond to the running command. Users should first cancel running command, after running command coming into valid again, the inverter then responds.</p>					

Section V. Parameter Function Table

2.If running command is valid upon inverter fault reset, inverter will not respond to the running command. Running protection status can be eliminated after canceling the running command.

This can prevent the dangers caused by the automatic running of the motor under unexpected condition.

P8.19	Frequency detection value(FDT1)	0.00Hz~maximum frequency	50.00Hz	☆
P8.20	Frequency detection hysteresis value(FDT1)	0.0%~100.0%(FDT1level)	5.0%	☆

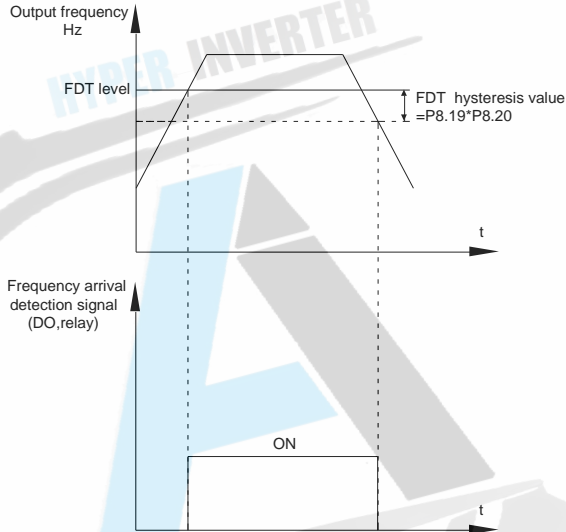

Fig.5-16 FDT level schematic diagram

When the running frequency is higher than the frequency detection value, multi-function terminal DO output ON signal. On the contrary, ON signal is canceled if running frequency is less than a certain value of the detection value.

It is used to set the detection value of the output frequency and the hysteresis value upon release of the output action. P8.20 is the hysteresis frequency percentage relating to P8.19 frequency detection value.

P8.21	Frequency arrival detection amplitude	0.00~100%maximum frequency	0.0%	☆
-------	---------------------------------------	----------------------------	------	---

When inverter running frequency is in certain target frequency, multi-function terminal DO outputs ON signal.

P8.21 is used to set frequency arrival detection amplitude, percentage relating to the maximum frequency. Frequency arrival schematic diagram is shown in Fig5-17.

Section V. Parameter Function Table

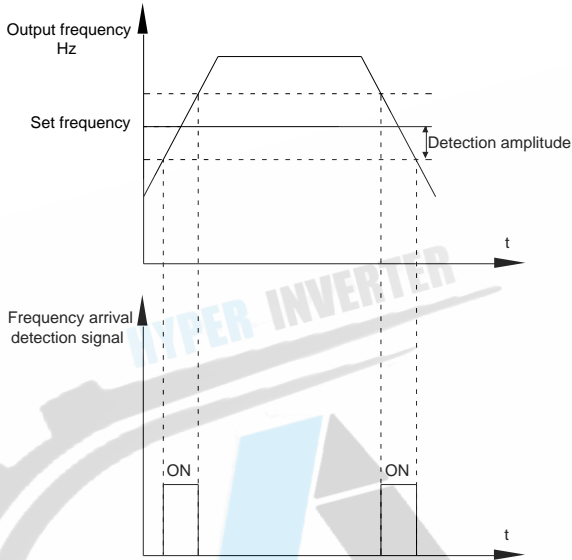

Fig.5-17 Frequency arrival detection amplitude schematic diagram

P8.22	Acc./dec. hopping frequency validity	Invalid	0	0	☆
		Valid	1		

It is used to set whether hopping frequency is effective during process of acceleration/deceleration.

P8.22 =1: Actual running frequency will skip the setting frequency boundary when running within the range of hopping frequency.

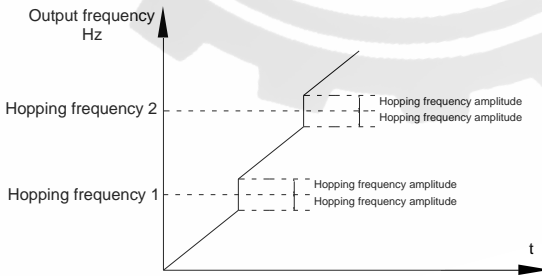

Fig.5-18 Acc./dec. hopping frequency validity schematic diagram

P8.25	Acc. time1 & acc. time 2 frequency switching point	0.00Hz~Maximum frequency	0.00Hz	☆
-------	--	--------------------------	--------	---

Section V. Parameter Function Table

P8.26	Dec. time1 & dec. time 2 frequency switching point	0.00Hz~Maximum frequency	0.00Hz	☆
<p>It is valid when motor 1 is selected without switching acceleration / deceleration time through DI terminal. In inverter running process, P8.25 & P8.26 choose different acceleration / deceleration time according to the running frequency range.</p> <p>As shown in fig.5-19:</p> <p>During acceleration process, if running frequency is less than P8.25, then choose acc. time2. If running frequency is greater than P8.25, choose acc. time 1.</p> <p>During deceleration process, if running frequency is greater than P8.26, then choose dec. time 1. If running frequency is less than P8.26, choose dec. time 2.</p> <p>Fig.5-19 Acc./dec. Time switching schematic diagram</p>				
P8.27	Terminal jog priority	Invalid	0	☆
		Valid	1	
<p>It is used to set if terminal jog function has the highest priority.</p> <p>When P8.27 is valid, if jog command occurring during running, inverter will switch to jog running mode.</p>				
P8.28	Frequency detection value(FDT2)	0.00Hz~Maximum frequency	50.00Hz	☆
P8.29	Frequency detection hysteresis value(FDT2)	0.0%~100.0%(FDT2 level)	5.0%	☆
<p>This frequency detection function and FDT1 function are exactly the same, for details please refer to FDT1, namely function codes P8.19, P8.20 description.</p>				
P8.30	Random frequency arrival detection value1	0.00Hz~Maximum frequency	50.00Hz	☆

Section V. Parameter Function Table

P8.31	Random frequency arrival detection range1	0.0%~100.0%(Maximum frequency)	0.0%	☆
P8.32	Random frequency arrival detection value2	0.00Hz~Maximum frequency	50.00Hz	☆
P8.33	Random frequency arrival detection range2	0.0%~100.0%(Maximum frequency)	0.0%	☆

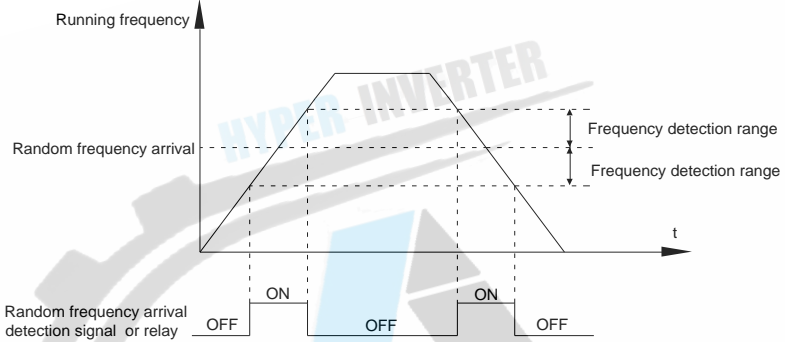

Fig.5-20 Random frequency arrival detection schematic diagram

When inverter output frequency is within the positive & negative detection range of random frequency arrival detection value , multi-funfion terminal DO output ON signal.

P8.34	Zero-current detection level	0.0%~300.0%(Motor rated current)	5.0%	☆
P8.35	Zero-current detection delay time	0.00s~600.00s	0.10s	☆

When inverter output current is less than or equals to zero-current detection level, and the lasting time exceeds zero-current detection delay time, inverter multi-funfion terminal DO output DO signal. Fig.5-21 is schematic diagram of zero-current detection.

Section V. Parameter Function Table

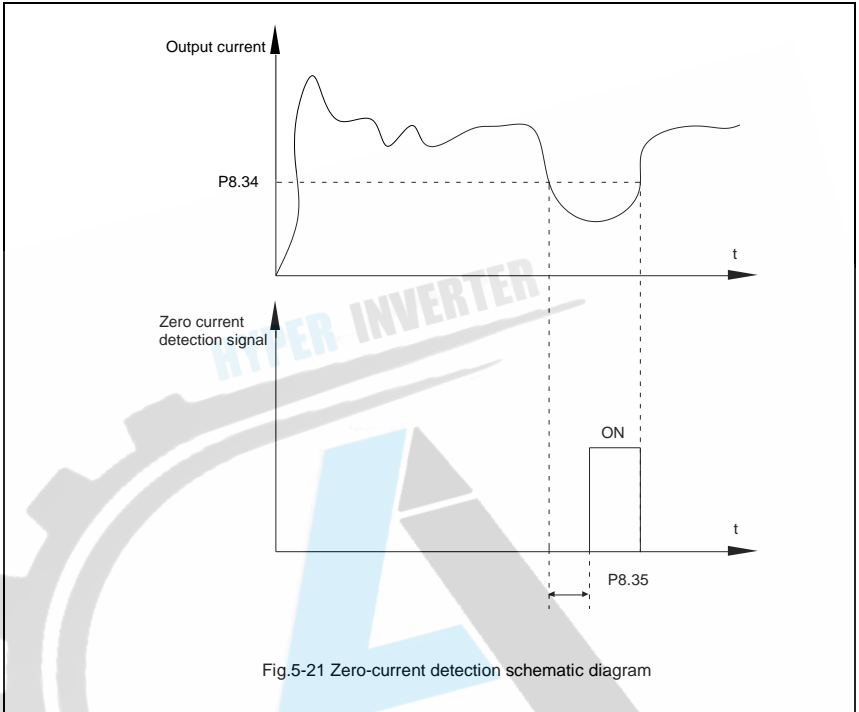

Fig.5-21 Zero-current detection schematic diagram

P8.36	Output current over limit value	0.0%(No detection) 0.1%~300.0%(Motor rated current)	200.0%	☆
P8.37	Output current over limit detection delay time	0.00s~600.00s	0.00s	☆

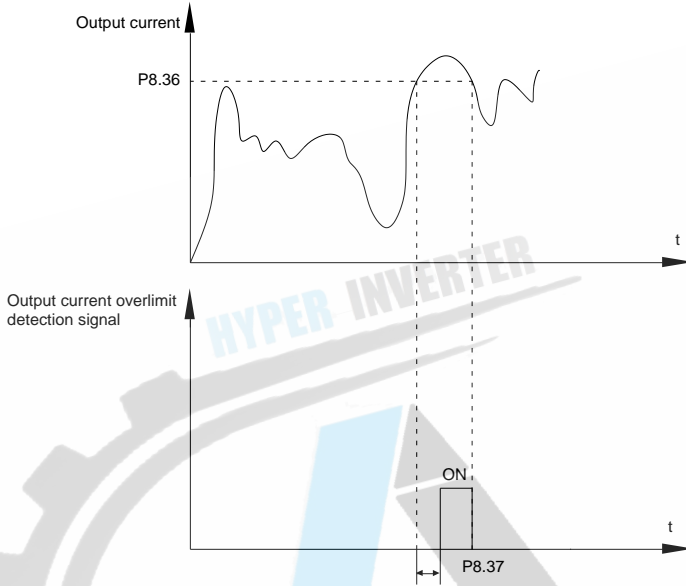

Fig.5-22 Output current over limit detection schematic diagram

When inverter output current is larger than output current over limit value(P8.36) ,and lasting time exceeds the software over limit detection delay time ,inverter multi-function terminal DO output ON signal, fig.5-22 is schematic diagram of output current over limit detection.

P8.38	Random current arrival 1	0.0%~300.0%(Motor rated current)	100.0%	☆
P8.39	Random current arrival range1	0.0%~300.0%(Motor rated current)	0.0%	☆
P8.40	Random current arrival 2	0.0%~300.0%(Motor rated current)	100.0%	☆
P8.41	Random current arrival range2	0.0%~300.0%(Motor rated current)	0.0%	☆

When inverter output current is within the positive & negative detection range of Random arrival current value , multi-funtion terminal DO output ON signal.

DSI-400 offers two groups of Random current arrival range detection parameters ,as shown in fig. 5-23.

Section V. Parameter Function Table

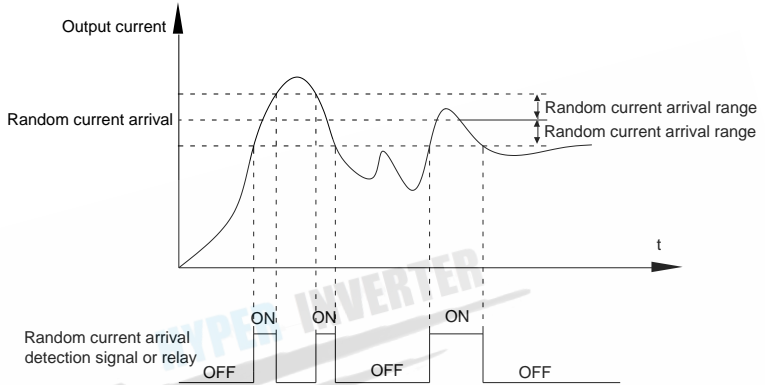

Fig.5-23 Random current arrival detection schematic diagram

P8.42	Timing function selection	Invalid	0	0	☆
		Valid	1		
P8.43	Running time timing selection	P8.44 setup	0	0	☆
		A11	1		
		A12	2		
		A13(Potentiometer)	3		
Analog input range 100% corresponds to P8.44.					
P8.44	Timing running time	0.0Min~6500.0Min		0.0Min	☆
<p>This parameter group is used to time inverter running time.</p> <p>When P8.42 is valid, inverter starts timing. Inverter would automatically stop after reaching the timing setup , multi-function terminal DO output ON signal.</p> <p>Each time inverter startup from 0 start the timing, timing surplus running time could be viewed through U0.20. Timing of the operation time is set through P8.43, P8.44, unit minute.</p>					
P8.45	A11 input voltage protection value lower limit	0.00V~P8.46		3.10V	☆
P8.46	A11 input voltage protection value upper limit	P8.45~10.00V		6.80V	☆
<p>When analog input A11 is greater than the set of P8.46 or less than that of P8.47, inverter multi-function DO output ON signal of "A11 input overrun" , which indicating if A11 input voltage is within the setup range.</p>					

Section V. Parameter Function Table

P8.47	Module temperature arrival	0.00℃~100℃	75℃	☆
<p>Inverter multi-function terminal DO outputs "module temperature arrival" ON signal when inverter radiator temperature arrived the set value of P8.47.</p>				
P8.48	Cooling fan control	Cooling fan runs at motor operation	0	0 ☆
		Cooling fan runs after power-on	1	
<p>It is used to select cooling fan action mode.</p> <p>P8.48=0: Cooling fan operates when inverter in running status or radiator temperature over 40℃ in inverter stop status.the fan does not operate when inverter in stopping status and radiator temperature below 40℃</p> <p>P8.48=1: Cooling fan is always running after power-on.</p>				
P8.49	Wake up frequency	Sleep frequency(P8.51) ~maximum frequency (P0.10)	0.00Hz	☆
P8.50	Wake up delay time	0.0s~6500.0s	0.0s	☆
P8.51	Sleep frequency	0.00Hz~wake-up frequency(P8.49)	0.00Hz	☆
P8.52	Sleep delay time	0.0s~6500.0s	0.0s	☆
<p>This group of function codes are used to realize sleep and wake up function.</p> <p>During operation: when set frequency is less than or equals to sleep frequency(P8.51), inverter would step into sleep state and stop after sleep delay time(P8.52).</p> <p>If inverter is in sleep state and current running command is valid, when set frequency is no less than P8.49 wake-up frequency, inverter will start to run after P8.50 wake-up delay time.</p> <p>Generally, please set wake-up frequency no less than sleep frequency. Sleep function and wake-up function are valid when both wake-up frequency and sleep frequency are set to 0.00 Hz.</p> <p>When enabling sleep function(frequency source : PID) , PID calculation selection in sleep state is influenced by function code PA.28(PA.28=1).</p>				
P8.53	The running time arrival	0.0Min~6500.0Min	0.0Min	☆
<p>When the running time reached the P8.53 set value, inverter multi-function DO output "Then running time arrival" ON signal.</p>				
P8.54	Out power correction coefficient	0.00~200.00%	100.0%	☆

5-11 Overload and protection: P9.00-P9.70

Section V. Parameter Function Table

Code	Description/ Keyboard Display	Setting Range		Factory Setting	Change Limit
P9.00	Motor overload protection selection	Invalid	0	1	☆
		Valid	1		
P9.01	Motor overload protection gain	0.20~10.00		1.00	☆
<p>P9.00=0: Without motor overload protection function. It is recommended to install a thermal relay between the motor and the inverter.</p> <p>P9.00=1: The inverter has overload protection function for the motor according to motor overload protection inverse time limit curve.</p> <p>Motor overload protection inverse time limit curve: $220\% \times (P9.01) \times$ motor rated current, it will report motor overload fault after it lasts for one minute. When the operating current of the motor reaches the current of $150\% \times (P9.01)$ times the rated current of the motor, it will report motor overload after it lasts 60 minutes.</p> <p>Users can set value of P9.01 according to the motor actual overload ability. If the parameter is set too big, it may cause danger of motor overheating damage without inverter fault report.</p>					
P9.02	Motor overload pre-alarm coefficient	50%~100%		80%	☆
<p>This function is used before motor overload fault by giving pre-alarm signal through multi-function terminal DO. This pre-alarm coefficient is used to determine the warning timing before motor overload protection. The higher the value, the shorter the warning timing will be.</p> <p>When the inverter output current is accumulated more than the product of inverse time limit curve with P9.02, multi-function terminal DO output "Motor overload pre-alarm" ON signal.</p>					
P9.03	Over-voltage stall gain	0(no over-voltage stall)~100		30	☆
P9.04	Over-voltage stall protection voltage	650~800v		770	☆
<p>Over voltage stall: When the output voltage of the inverter reaches setup of over voltage stall protection voltage (P9.04), if the inverter is running with acceleration speed, it will stop acceleration. When the inverter is running with constant speed, it will reduce the output frequency. When the inverter is running with deceleration speed, it will stop deceleration and the operating frequency will not recover normally till the current is less than the current stall protection current (P9.04).</p> <p>Over voltage stall protection voltage: It selects the protection point for over current stall function. When the value is exceeded, the inverter starts to execute the over voltage stall protection function. This value is relative to the percentage of rated voltage of the motor.</p> <p>Overvoltage stall gain: It adjusts the inverter's capacity in suppressing the voltage stall. The bigger the value is, the stronger the capacity is. For the load with small inertia, the value should be small. Otherwise, the dynamic response of the system would be slow. For the load with large inertia, the value should be large. Otherwise, the suppressing result will be poor, and over voltage fault may be caused.</p> <p>When the voltage stall gain is set to 0, the inverter starts to execute the over voltage stall protection</p>					

Section V. Parameter Function Table

function.						
P9.07	Ground short circuit protection upon power-on	Invalid	0	1	☆	
		Valid	1			
It determines whether the motor has ground short circuit fault upon power-on. If this function is valid, the inverter UVW end will output voltage within the period of time after power-on.						
P9.08	Braking unit applied voltage	650-800v		7 60v	☆	
When the dc bus voltage is higher than P9.08, the internal braking of inverter unit works.						
P9.09	Fault auto reset times	0~20		0	☆	
When the inverter selects fault auto reset, it is used to set the times of auto reset. If this value is exceeded, the inverter will perform fault protection.						
P9.10	Fault auto reset FAULTDO selection	No action	0	0	☆	
		Action	1			
If inverter has been set of fault auto reset function , P9.10 is used to set if FAULT DO actions or not during fault auto reset time.						
P9.11	Fault auto reset interval	0.1s~100.0s		1.0s	☆	
The waiting time of the inverter from the fault alarm to auto reset.						
P9.12	Input phase lack protection selection	1bit	Input phase lack protection selection		11	☆
		Forbidden		0		
		Allowed		1		
		10bit	Contactor attracting protection			
		Forbidden		0		
		Allowed		1		
<p>1bit: It is used to choose whether to protect input phase loss.</p> <p>10bit: Contactor attracting protection</p> <p>DSI-400 series inverter above 132kW (type G) has input phase fault protection function.For the inverter below 132kW (type P), the input phase fault protection function is invalid at any setup.</p>						
P9.13	Output phase lack protection selection	Invalid	0	1	☆	
		valid	1			

Section V. Parameter Function Table

It is used to choose whether to protect output open-phase.				
P9.14	The first fault type	0~99	-	•
P9.15	The second fault type	0~99	-	•
P9.16	The latest fault type	0~99	-	•
It records the latest 3 fault types for the inverter: 0 means no fault and 1 to 99 correspond to refer to Chapter 6 for the details.				
Table of fault type :				
No.	Fault display	Fault type		
0	Reserved	No fault		
1	1=Err01	Reserved		
2	2= Err02	Acceleration over current		
3	3= Err03	Deceleration over current		
4	4=Err04	Constant speed over current		
5	5=Err05	Acceleration over voltage		
6	6= Err06	Deceleration over voltage		
7	7=Err07	Constant speed over voltage		
8	8=Err08	Control power supply fault		
9	9=Err09	Under voltage fault		
10	10=Err10	Inverter overload		
11	11= Err11	Motor overload		
12	12= Err12	Input phase lack		
13	13= Err13	Output phase lack		
14	14= Err14	Module overheating		
15	15= Err15	External equipment fault		
16	16= Err16	Communication fault		

Section V. Parameter Function Table

17	17=Err17	Contactor fault	
18	18= Err18	Current inspection fault	
19	19= Err19	Motor tuning fault	
20	20= Err20	Encoder /PG card fault	
21	21= Err21	EEPROM read & write fault	
22	22= Err22	Inverter hardware fault	
23	23= Err23	Short circuit to ground fault	
24	Reserved	Reserved	
25	Reserved	Reserved	
26	26= Err26	Total running time arrival fault	
27	27= Err27	User-defined fault 1	
28	28=Err28	User-defined fault 2	
29	29=Err29	Total power-on time arrival fault	
30	30= Err30	Load off fault	
31	31= Err31	PID feedback loss during operation fault	
40	40= Err40	Each wave current limiting fault	
41	41=Err41	Motor switching fault	
42	42= Err42	Excessive speed deviation fault	
43	43= Err43	Motor over speed fault	
45	45=Err45	Motor over temperature fault	
51	51= Err51	Initial position fault	
Pg.17	Third fault frequency	The latest fault frequency	•
Pg.18	Third fault current	The latest fault current	•

Section V. Parameter Function Table

P9.19	Third fault bus voltage	The latest fault bus voltage	•																				
P9.20	Third fault input terminal	<p>The latest fault digital input terminal status, order as below:</p> <table border="1" style="margin-left: auto; margin-right: auto;"> <tr> <td>BIT9</td><td>BIT8</td><td>BIT7</td><td>BIT6</td><td>BIT5</td><td>BIT4</td><td>BIT3</td><td>BIT2</td><td>BIT1</td><td>BIT0</td> </tr> <tr> <td>D10</td><td>D19</td><td>D18</td><td>D17</td><td>D16</td><td>D15</td><td>D14</td><td>D13</td><td>D12</td><td>D11</td> </tr> </table> <p>When input terminal status is ON, it's corresponding binary digit is 1. OFF corresponds to 0. All DI status are converted to decimal display.</p>	BIT9	BIT8	BIT7	BIT6	BIT5	BIT4	BIT3	BIT2	BIT1	BIT0	D10	D19	D18	D17	D16	D15	D14	D13	D12	D11	•
BIT9	BIT8	BIT7	BIT6	BIT5	BIT4	BIT3	BIT2	BIT1	BIT0														
D10	D19	D18	D17	D16	D15	D14	D13	D12	D11														
P9.21	Third fault output terminal	<p>The latest fault digital output terminal status, order as below :</p> <table border="1" style="margin-left: auto; margin-right: auto;"> <tr> <td>BIT4</td><td>BIT3</td><td>BIT2</td><td>BIT1</td><td>BIT0</td> </tr> <tr> <td>DO2</td><td>DO1</td><td>REL2</td><td>REL1</td><td>FMP</td> </tr> </table> <p>When output terminal status is ON, it's corresponding binary digit is 1. OFF corresponds to 0. All status are converted to decimal display.</p>	BIT4	BIT3	BIT2	BIT1	BIT0	DO2	DO1	REL2	REL1	FMP	•										
BIT4	BIT3	BIT2	BIT1	BIT0																			
DO2	DO1	REL2	REL1	FMP																			
P9.22	Third fault inverter state	Reserved	•																				
P9.23	Third fault power-on time	The latest fault power-on time	•																				
P9.24	Third fault running time	The latest fault running time	•																				
P9.27	Second fault frequency	The latest fault frequency	•																				
P9.28	Second fault current	The latest fault current	•																				
P9.29	Second fault bus voltage	The latest fault bus voltage	•																				
P9.30	Second fault input terminal	<p>The latest fault digital input terminal status, order as below :</p> <table border="1" style="margin-left: auto; margin-right: auto;"> <tr> <td>BIT9</td><td>BIT8</td><td>BIT7</td><td>BIT6</td><td>BIT5</td><td>BIT4</td><td>BIT3</td><td>BIT2</td><td>BIT1</td><td>BIT0</td> </tr> <tr> <td>D10</td><td>D19</td><td>D18</td><td>D17</td><td>D16</td><td>D15</td><td>D14</td><td>D13</td><td>D12</td><td>D11</td> </tr> </table> <p>When input terminal status is ON, it's corresponding binary digit is 1. OFF corresponds to 0. All DI status are converted to decimal display.</p>	BIT9	BIT8	BIT7	BIT6	BIT5	BIT4	BIT3	BIT2	BIT1	BIT0	D10	D19	D18	D17	D16	D15	D14	D13	D12	D11	•
BIT9	BIT8	BIT7	BIT6	BIT5	BIT4	BIT3	BIT2	BIT1	BIT0														
D10	D19	D18	D17	D16	D15	D14	D13	D12	D11														
P9.31	Second fault output terminal	The latest fault digital input terminal status, order as below :	•																				

Section V. Parameter Function Table

		<table border="1"> <tr> <td>BIT4</td> <td>BIT3</td> <td>BIT2</td> <td>BIT1</td> <td>BIT0</td> </tr> <tr> <td>DO2</td> <td>DO1</td> <td>REL2</td> <td>REL1</td> <td>FMP</td> </tr> </table> <p>When output terminal status is ON, it's corresponding binary digit is 1. OFF corresponds to 0. AllIDO status are converted to decimal display.</p>	BIT4	BIT3	BIT2	BIT1	BIT0	DO2	DO1	REL2	REL1	FMP											
BIT4	BIT3	BIT2	BIT1	BIT0																			
DO2	DO1	REL2	REL1	FMP																			
P9.32	Second fault inverter state	Reserved	•																				
P9.33	Second fault power-on time	The latest fault power-on time	•																				
P9.34	Second fault running time	The latest fault running time	•																				
P9.37	First fault frequency	The latest fault frequency	•																				
P9.38	First fault current	The latest fault current	•																				
P9.39	First fault bus voltage	The latest fault bus voltage	•																				
P9.40	First fault input terminal	<p>The latest fault digital input terminal status, order as below :</p> <table border="1"> <tr> <td>BIT9</td> <td>BIT8</td> <td>BIT7</td> <td>BIT6</td> <td>BIT5</td> <td>BIT4</td> <td>BIT3</td> <td>BIT2</td> <td>BIT1</td> <td>BIT0</td> </tr> <tr> <td>DI0</td> <td>DI9</td> <td>DI8</td> <td>DI7</td> <td>DI6</td> <td>DI5</td> <td>DI4</td> <td>DI3</td> <td>DI2</td> <td>DI1</td> </tr> </table> <p>When input terminal status is ON, it's corresponding binary digit is 1. OFF corresponds to 0. All DI status are converted to decimal display.</p>	BIT9	BIT8	BIT7	BIT6	BIT5	BIT4	BIT3	BIT2	BIT1	BIT0	DI0	DI9	DI8	DI7	DI6	DI5	DI4	DI3	DI2	DI1	•
BIT9	BIT8	BIT7	BIT6	BIT5	BIT4	BIT3	BIT2	BIT1	BIT0														
DI0	DI9	DI8	DI7	DI6	DI5	DI4	DI3	DI2	DI1														
P9.41	First fault output terminal	<p>The latest fault digital input terminal status, order as below :</p> <table border="1"> <tr> <td>BIT4</td> <td>BIT3</td> <td>BIT2</td> <td>BIT1</td> <td>BIT0</td> </tr> <tr> <td>DO2</td> <td>DO1</td> <td>REL2</td> <td>REL1</td> <td>FMP</td> </tr> </table> <p>When output terminal status is ON, it's corresponding binary digit is 1. OFF corresponds to 0. AllIDO status are converted to decimal display.</p>	BIT4	BIT3	BIT2	BIT1	BIT0	DO2	DO1	REL2	REL1	FMP	•										
BIT4	BIT3	BIT2	BIT1	BIT0																			
DO2	DO1	REL2	REL1	FMP																			
P9.42	First fault inverter state	Reserved	•																				
P9.43	First fault power-on time	The latest fault power-on time	•																				
P9.44	First fault running time	The latest fault running time	•																				
P9.47	Fault protection action selection 1	<table border="1"> <tr> <td>1bit</td> <td>Motor overload(Fault No.11= Err11)</td> <td rowspan="2">00000</td> <td rowspan="2">☆</td> </tr> <tr> <td>Free stop</td> <td>0</td> </tr> </table>	1bit	Motor overload(Fault No.11= Err11)	00000	☆	Free stop	0															
1bit	Motor overload(Fault No.11= Err11)	00000	☆																				
Free stop	0																						

Section V. Parameter Function Table

		Stop according to stop mode	1		
		Keep on running	2		
		10bit	Input phase lack(Fault No 12=Err12)		
		Free stop	0		
		Stop according to stop mode	1		
		100 bit	Input phase lack(Fault No 13=Err13)		
		Free stop	0		
		Stop according to stop mode	1		
		1000 bit	External fault(Fault No.15=Err15)		
		Free stop	0		
		Stop according to stop mode	1		
		10000 bit	Abnormal communication(Fault No.16=Err16)		
		Free stop	0		
		Stop according to stop mode	1		
P9.48	Fault protection action selection 2	1bit	Encoder fault (Fault No.20=Err20)	00000	☆
		Free stop	0		
		Switch to VF, stop according to stop mode	1		
		Switch to VF, keep on running	2		
		10bit	Abnormal communication(Fault No.21=Err21)		
		Free stop	0		
		Stop according to stop mode	1		
		100bit	Reserved		
1000	Motor overheating(Fault No.45= Err45)				

Section V. Parameter Function Table

		bit	(Same with P9.47 1 bit)			
		10000 bit	Running time arrival(Fault No.26= Err26) (Same with P9.47 1 bit)			
P9.49	Fault protection action selection 3	1bit	User-defined fault 1(Fault No.27= Err27) (Same with P9.47 1 bit)	00000	☆	
		10bit	User-defined fault 2(Fault No.28= Err28) (Same with P9.47 1 bit)			
		100bit	Power-on time arrival(Fault No.29= Err29) (Same with P9.47 1 bit)			
		1000 bit	Load off(Fault No.30= Err30)			
		Free stop				0
		Stop according to stop mode				1
		Decelerate to 7% of motor rated frequency. Automatically recover to the set frequency if no load off.				2
		10000 bit	PID feedback lost during operation(Fault No.31= Err31) (Same with P9.47 1 bit)			
P9.50	Fault protection action selection 4	1bit	Excessive speed deviation(Fault No.42= Err42) (Same with P9.47 1 bit)	00000	☆	
		10bit	Motor super velocity(Fault No.43= Err43)(Same with P9.47 1 bit)			
		100bit	Initial position fault(Fault No.51= Err51) (Same with P9.47 1 bit)			
		1000 bit	Reserved			
		10000 bit	Reserved			
<p>If it is set to "free stop", inverter displays E.****, and stop directly.</p> <p>If it is set to "stop according to stop mode", inverter displays A.****, and stop according to the set stop mode. Inverter displays E.**** after stopped.</p>						

Section V. Parameter Function Table

<p>If it is set to "keep on running", inverter displays A.**** and continues running. Running frequency is set through P9.54.</p>					
P9.54	Continued to run when fault frequency selection	Operation with the current running frequency	0	0	☆
		Operation with the set frequency	1		
		Operation with the upper limit frequency	2		
		Operation with the lower limit frequency	3		
		Operation with the abnormal backup frequency	4		
P9.55	Abnormal backup frequency	60.0%~100.0%	100.0%	☆	
<p>When fault occurring during inverter operation , and the fault processing mode set to continuing to run, inverter would display A** and run with the P9.54 set frequency.</p> <p>When choosing running frequency as abnormal backup frequency, set value of P9.55 is percentage of the maximum frequency.</p>					
P9.56	Reserved	Reserved			☆
P9.57	Reserved	Reserved			☆
P9.58	Reserved	Reserved			☆
P9.59	Transient stop selection	Invalid	0	0	☆
		Deceleration	1		
		Deceleration to stop	2		
P9.60	Transient stop action pause protection voltage	80.0%~100.0%	90.0%	☆	
P9.61	Transient stop voltage recovery judgment time	0.00s~100.00s	0.50s	☆	
P9.62	Transient stop action judgment voltage	60.0%~100.0%(Standard bus voltage)	80.0%	☆	

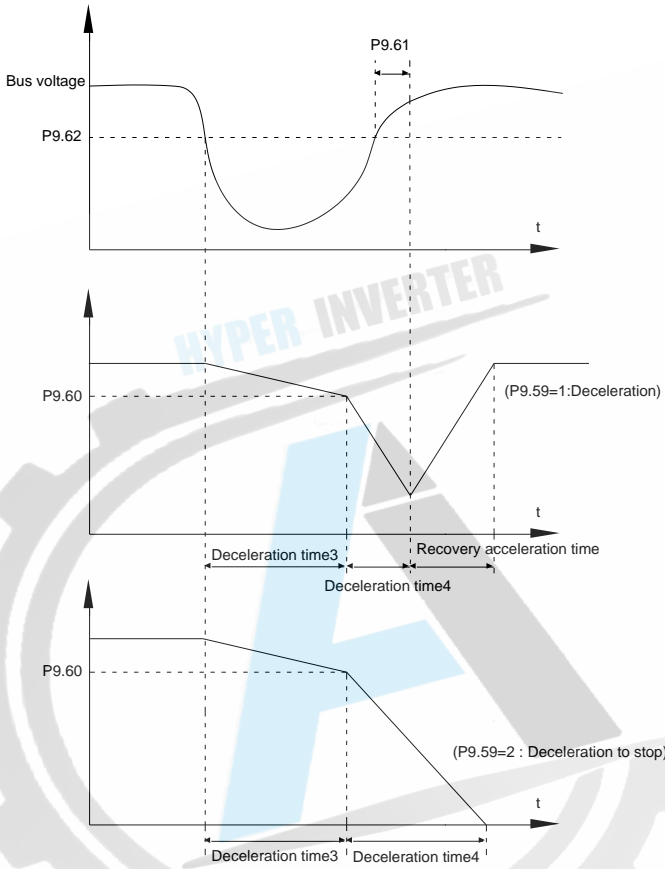

Fig.5-24 Transient stop action schematic diagram

The function defines when instant outage or voltage suddenly drops, inverter compensating dc bus voltage decrease by load feedback energy through decreasing output revolving speed, which maintaining inverter running.

P9.59=1: When instant outage or voltage suddenly drops, inverter decelerates. Inverter normally accelerates to the set running frequency until bus voltage came to normal. Bus voltage has restored to normal is based on normal bus voltage duration time. If the time exceeds P9.61 set value , bus voltage is normal.

P9.59=2: When instant outage or voltage suddenly drops, inverter decelerates to stop.

P9.63	Load-off protection selection	Invalid	0	0	☆
		Valid	1		

Section V. Parameter Function Table

P9.64	Load-off detection level	0.0%~100.0%(Motor rated current)	10.0%	☆
P9.65	Load-off detection time	0.0s~60.0s	1.0s	☆
<p>When the protection function is valid and inverter output current is less than load-off detection level P9.64(duration time > P9.65), inverter output frequency automatically decreased to 7% of the rated frequency. In the load-off protection period, if the load restored, the inverter automatically restore to the set running frequency.</p>				
P9.67	Over speed detection value	0.0%~50.0%(Maximum frequency)	20.0%	☆
P9.68	Over speed detection time	0.0s~60.0s	1.0s	☆
<p>This function is only valid in speed sensor vector control.</p> <p>Inverter fault alarm when motor actual revolving speed exceeds the set frequency(excess value > P9.67 ,duration time > P9.68) .Fault No. 43=Err43.</p>				
P9.69	Excessive speed deviation detection value	0.0%~50.0%(Maximum frequency)	20.0%	☆
P9.70	Excessive speed deviation detection time	0.0s~60.0s	5.0s	☆
<p>This function is only valid in speed sensor vector control.</p> <p>Inverter fault alarms when deviation detected between motor actual revolving speed and the set frequency(deviation>P9.69, duration time>P9.70). Fault No. 42=Err42.</p> <p>P9.70=0.0s: Excessive speed deviation fault detection is canceled.</p>				
P9.71	Power dip ride-through gain kp	0-100	40	☆
P9.72	Power dip ride-through integral coefficient ki	0-100	30	☆
P9.73	Deceration time of Power dip ride-through	0-300.0s	20.0s	☆

5-12 PID function group: PA.00-PA.28

PID control is a common method used in process control. Through the proportional, integration and differential calculation on the difference between feedback signal and target signal of the controlled parameter, PID control adjusts the output frequency of the inverter and forms negative feedback system, making the controlled parameter stabilized on the target parameter. PID control is applied to several process controls such as flow control, pressure control and temperature control. The schematic diagram for control is as shown in Fig. 5-25.

Section V. Parameter Function Table

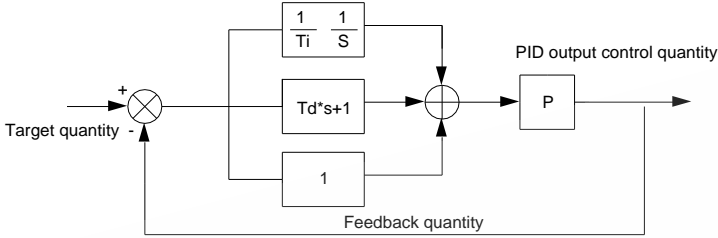

Fig.5-25PID process schematic diagram

Code	Description/ Keyboard Display	Setting Range		Factory Setting	Change Limit
PA.00	PID reference source	PA.01 setup	0	0	☆
		A11	1		
		A12	2		
		A13(Potentiometer)	3		
		PULSE(DI5)	4		
		Communication	5		
		MS command	6		
PA.01	PID reference value	0.0%~100.0%		50.0%	☆
<p>It is used to select target parameter reference channel of process PID.</p> <p>Set target value of process PID is a relative value, set range is 0.0%~100.0%. PID feedback value is a relative value as well,PID play the role of making the two relative value the same.</p>					
PA.02	PID feedback source	A11	0	0	☆
		A12	1		
		A13(Potentiometer)	2		
		A11 – A12	3		
		PULSE(DI5)	4		
		Communication	5		
		A11+A12	6		
		MAX(A11 , A12)	7		

Section V. Parameter Function Table

		MIN(A1 , A2)	8		
<p>It is used to select the feedback channel of PID</p> <p>Feedback value of process PID is a relative value, set range is 0.0%~100.0%.</p>					
PA.03	PID action direction	Positive action	0	0	☆
		Negative action	1		
<p>Positive action: If the feedback signal is smaller than the PID reference signal, it is required to boost the output frequency of the inverter to make PID reach balance. The winding tension PID control is such a case.</p> <p>Negative action: If the feedback signal is smaller than the PID reference signal, it is required to decrease the output frequency of the inverter to make PID reach balance. The unwinding tension PID control is such a case.</p> <p>This function is influenced by function 35, please pay attention during operation.</p>					
PA.04	PID reference feedback range	0~65535		1000	☆
<p>PID reference feedback range is a dimensionless unit which is used to display U0.15 PID setup and U0.16 PID feedback.</p> <p>PID reference feedback related to the value 100.0%, corresponding to a given feedback range PA.04. If PA.40 is set to 2000, PID is set to 100.0%, PID given display U0.15 is 2000.</p>					
PA.05	Proportional gain K_{p1}	0.0~100.0		20.0	☆
PA.06	Integration time T_{i1}	0.01s~10.00s		2.00s	☆
PA.07	Differential time T_{d1}	0.00~10.000		0.000s	☆
<p>Proportional gain K_{p1}: the parameter determines the adjustable strength of PID regulator. The larger P is, the greater the adjustable strength will be. When the parameter is set to 100.0, it means that when the deviation between PID feedback value and reference value is 100.0%, the range for the PID regulator to regulate the output frequency commands is the maximum frequency (integration effect and differential effect are omitted).</p> <p>Integration time T_{i1}: determines the strength of PID integration regulation. The shorter the integration time, the greater adjustable strength will be. Integration time means that when the deviation between PID feedback value and reference value is 100%, the adjustment by the integration regulator (proportional effect and differential effect are omitted) after continuous adjustment in this period reaches the maximum frequency.</p> <p>Differential time T_{d1}: determines the degree of adjustment that PID regulator performs on the derivation between PID feedback value and reference value. Differential time means that if the feedback value changes 100% within this time, the adjustment by the differential regulator (proportional effect and differential effect are omitted) will reach the maximum frequency. The longer differential time is, the higher the degree of adjustment will be.</p>					

Section V. Parameter Function Table

PA.08	PID cutoff frequency of Reserved rotation	0.00~maximum frequency	2.00Hz	☆
<p>In some cases, only when the frequency of the PID output is negative (i.e., frequency inversion) could PID put the reference and feedback to the same state. High inversion frequency is not allowed in some certain cases, PA.08 is used to determine Reserved frequency upper limit.</p>				
PA.09	PID deviation limit	0.0%~100.0%	0.0%	☆
<p>It is used to set the maximum allowable deviation between the system feedback value and reference value. When the deviation between the PID feedback and reference is within this range, the PID stops adjustment. The deviation limit is calculated according to the percentage of the PID setup source (or feedback source).When deviation between reference value and the feedback value is small,output frequency is stability constant.It's especially effective for some closed loop control occasions.</p>				
PA.10	PID differential amplitude limit	0.00%~100.00%	0.10%	☆
<p>In PID regulation, the role of differential is relatively sensitive that system oscillation may be easily caused. Therefore, range of PID differential regulation has been limited to a small range. PA.10 is used to set PID differential output range.</p>				
PA.11	PID reference change duration	0.00s~650.00s	0.00s	☆
<p>PID reference changes according to this parameter value, which corresponds to the time taken for the PID reference to change from 0% to 100%.</p> <p>When PID reference changed,PID given value linear changes in accordance with given time,which can reduce system adverse effect caused by given mutation.</p>				
PA.12	PID feedback filter time	0.00s~60.00s	0.00s	☆
PA.13	PID output filter time	0.00s~60.00s	0.00s	☆
<p>PA.12 is used for filtering of PID feedback. The filtering helps to reduce the influence of the feedback interference, but brings response performance of process closed-loop system.</p> <p>PA.13 is used for filtering of PID output frequency. The filtering helps to reduce the mutations of the output frequency, but brings response performance of process closed-loop system.</p>				
PA.14	Reserved	-	-	-
PA.15	Proportional gain K_{p2}	0.0~100.0	20.0	☆
PA.16	Integration time T_{i2}	0.01s~10.00s	2.00s	☆
PA.17	Differential time T_{d2}	0.00~10.000	0.000s	☆
PA.18	PID parameter switching condition	No switching	0	0 ☆
		Switching through DI terminal	1	

Section V. Parameter Function Table

		Switching through deviation	2		
PA.19	PID parameter switching deviation1	0.0%~PA.20		20.0%	☆
PA.20	PID parameter switching deviation2	PA.19~100.0%		80.0%	☆

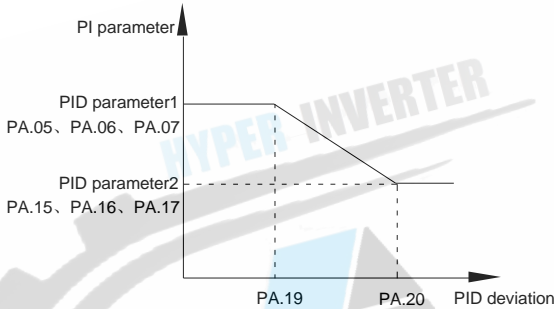

Fig.5-26PID parameter switching schematic diagram

In some applications, one group of PID parameters can not meet the needs of the whole operation process. Different parameters are used for different situations.

This group of function codes is used to switch 2 groups of PID parameters. Regulator parameters PA.15~PA.17 and parameter PA.05~PA.07 have the same setting method.

Two groups of PID parameters can be switched through multi-function digital DI terminal as well as PID deviation auto switching.

PA.18=1: Set multi-function terminal to 43(PID parameter switching terminal). Choose parameter group 1(PA.05~PA.07) when terminal invalid,while valid please choose parameter group 2(PA.15~PA.17).

PA.18=2: When deviation absolute value between reference and feedback is less than PA.19 set value, PID parameters select parameter group 1. When deviation absolute value between reference and feedback is greater than PA.20 set value, PID parameters select group 2. When deviation absolute value between reference and feedback is within the range of switching deviation 1 & 2 , PID parameters select linear interpolation value of the 2 PID parameter groups.As shown in 5-26.

PA.21	PID initial value	0.0%~100.0%		0.0%	☆
PA.22	PID initial value retention time	0.00s~650.00s		0.00s	☆

Inverter fixed startup value is PID initial value(PA.21) .PID starts closed-loop regulation after PID initial value retention time(PA.22).

Section V. Parameter Function Table

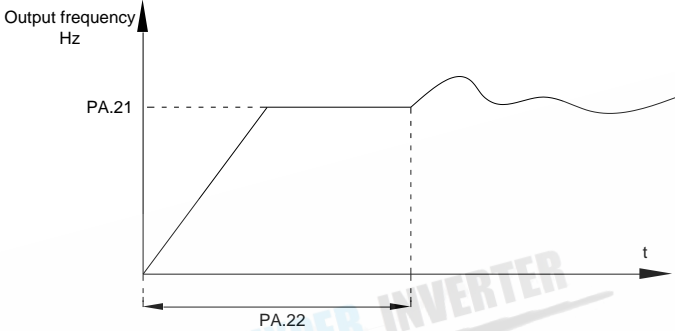

Fig.5-27 PID initial function schematic diagram

This function is used to limit difference between the PID output two beat (2ms/ beat), which suppressing rapid change of PID output, so that the inverter operation tends to be stable.

PA.23	Output deviation forward maximum value	0.00%~100.00%	1.00%	☆
PA.24	Output deviation Reserved maximum value	0.00%~100.00%	1.00%	☆

PA.23 and PA.24 correspond to the output deviation maximum absolute value of forward running and Reserved running respectively.

PA.25	PID integration attribute	1bit	Integration separation		00	☆
		Invalid		0		
		Valid		1		
		10bit	Whether stop integration when reaching output limit			
		Continue integration		0		
		Stop integration		1		

1bit : Integration separation

If integration separation valid, then when the multi-function digital DI integration suspended (function 22) effective, the PID integration stop operation, and only proportion and differential function effectively.

If integration separation invalid, regardless of validity of multi-function digital DI ,integration separation is invalid.

10bit : Whether stop integration when reaching output limit

When PID operation output reaches the maximum or minimum value, user could choose whether to stop integration or not.

Section V. Parameter Function Table

If you choose to stop integration, then the PID integration stops calculation, which may contribute to the reduction of PID overshoot.					
PA.26	PID feedback loss detection value	No judging	0.0%	0.0%	☆
		0.1%~100.0%	0.1%		
PA.27	PID feedback loss detection time	0.0s~20.0s		0s	☆
<p>This function is used to judge if PID feedback has been lost.</p> <p>When PID feedback value is less than PA.26 set value, and lasted for more than PA.27 set value, inverter fault alarm. Fault No. 31= Err31.</p>					
PA.28	PID stop operation	Stop without operation	0	0	☆
		Stop with operation	1		
It is used to select if PID keeping operation under PID stop status. Generally PA.28=0 in stop status.					

5-13 Fixed length and counting: Pb.05-Pb.09

The swing frequency function is applicable to textile and chemical fiber industries and applications where traversing and winding functions are required.

Swing frequency means that the inverter output frequency swings up and down with the setup frequency as the center, and the trace of running frequency at the time axis is as shown in Fig. 5-28. The swing amplitude is set by Pb.00 and Pb.01.

When Pb.01 is set to 0, it means the swing amplitude is 0, and the swing frequency is invalid.

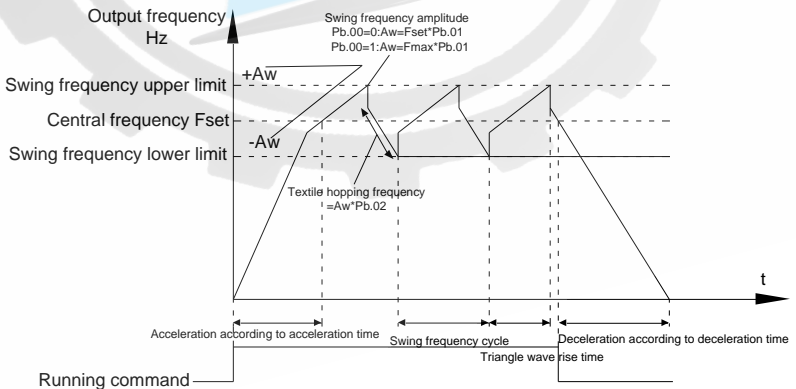

Fig.5-28Swing frequency schematic diagram

Code	Description/	Setting Range	Factory	Change
------	--------------	---------------	---------	--------

Section V. Parameter Function Table

	Keyboard Display		Setting	Limit
Pb.05	Setup length	0m~65535m	1000m	☆
Pb.06	Actual length	0m~65535m	0m	☆
Pb.07	Pulse number per meter	0.1~6553.5	100.0	☆

The three parameters such as setup length, actual length and number of pulses per meter are mainly used for fixed-length control.

Length information needs to be collected through multi-function digit input terminal, you can get Pb.06 actual length by division of terminal sampling pulse number and Pb.06. When actual length is longer than reference length Pb.05, multi-function digit terminal DO output "length arrival" ON signal.

During the process of fixed-length control, length reset operation (by multi-function terminal DI) is permitted (choose DI function selection as 28), for specifications please refer to P4.00~P4.09.

Set corresponded input terminal function to "length counting input" (function 27). When pulse frequency is high, only DI5 port can be used.

Pb.08	Counting value setup	1~65535	1000	☆
Pb.09	Designated counting value	1~65535	1000	☆

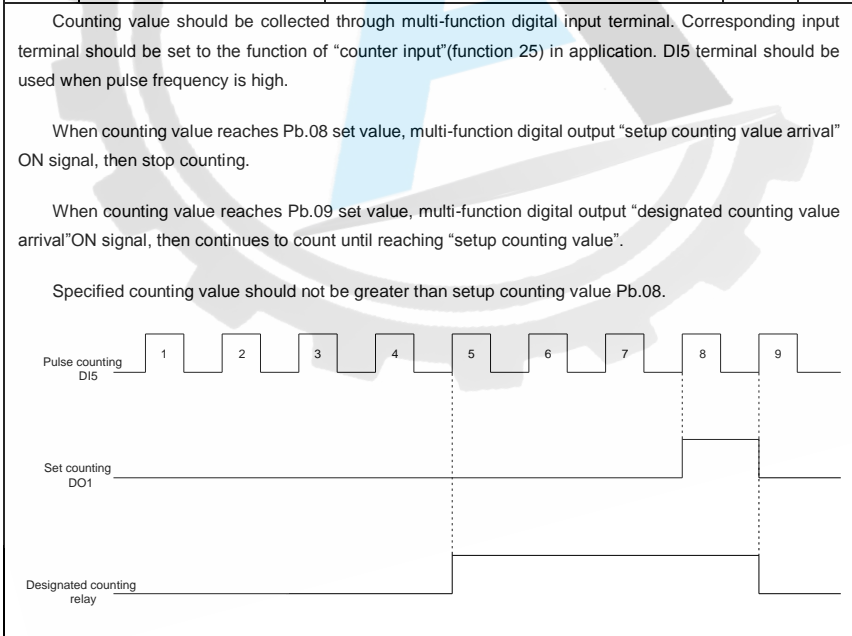

Fig.5-29 Setup counting value&designated counting value schematic diagram

5-14 MS speed function&simple PLC function: PC.00-PC.51

MS speed command of DSI-400 has more abundant function than the usual MS speed function. It could not only realize MS speed function, but also can be used as VF separation voltage source and PID reference source. Therefore, dimension of MS speed command is a relative value.

Simple PLC function is different from DSI-400 user programmable function. Simple PLC can only achieve simple combination of MS speed command, while user programmable function has more abundant and practical uses. For specifications please refer to A7 group.

Code	Description/ Keyboard Display	Setting Range	Factory Setting	Change Limit
PC.00	MS command 0	-100.0%~100.0%	0.0%	☆
PC.01	MS command 1	-100.0%~100.0%	0.0%	☆
PC.02	MS command 2	-100.0%~100.0%	0.0%	☆
PC.03	MS command 3	-100.0%~100.0%	0.0%	☆
PC.04	MS command 4	-100.0%~100.0%	0.0%	☆
PC.05	MS command 5	-100.0%~100.0%	0.0%	☆
PC.06	MS command 6	-100.0%~100.0%	0.0%	☆
PC.07	MS command 7	-100.0%~100.0%	0.0%	☆
PC.08	MS command 8	-100.0%~100.0%	0.0%	☆
PC.09	MS command 9	-100.0%~100.0%	0.0%	☆
PC.10	MS command 10	-100.0%~100.0%	0.0%	☆
PC.11	MS command 11	-100.0%~100.0%	0.0%	☆
PC.12	MS command 12	-100.0%~100.0%	0.0%	☆
PC.13	MS command 13	-100.0%~100.0%	0.0%	☆
PC.14	MS command 14	-100.0%~100.0%	0.0%	☆
PC.15	MS command 15	-100.0%~100.0%	0.0%	☆
<p>MS speed command can be used on three occasions: frequency source, VF separation voltage source, process PID set source.</p> <p>Dimension of MS speed command is a relative value ranging from -100.0% to 100.0%. When used as command source, it's the percentage of maximum frequency. When used as VF separation voltage source, it's the percentage of motor rated voltage. When used as PID set source, dimension conversion is not needed</p>				

Section V. Parameter Function Table

during the process.

MS command should be selected according to the different states of multi-function digit DI terminals. For details please refer to P4 group.

PC.16	PLC running mode	Single running stop	0	0	☆
		Single running end remaining final value	1		
		Continuous circulation	2		

Simple PLC command can be used on two occasions: frequency source, VF separation voltage source.

Fig 5-30 is the schematic diagram of simple PLC that used as frequency source. Positive & negative of PC.00-PC.15 determines the running direction.

PLC has 3 running modes as frequency source(VF separation voltage source is not provided with the 3 modes):

0: Single running stop

Upon completion of one single cycle of the inverter, it will stop automatically and will not start until running command is given again.

1: Single running end remaining final value

Upon completion of one single cycle of the inverter, the inverter will remain the running frequency and direction of last one phase. After the inverter restarted upon stop, it will run from the initial status of PLC.

2: Continuous circulation

Upon completion of one single cycle of the inverter, it will enter next cycle and not stop until stop command is given.

Section V. Parameter Function Table

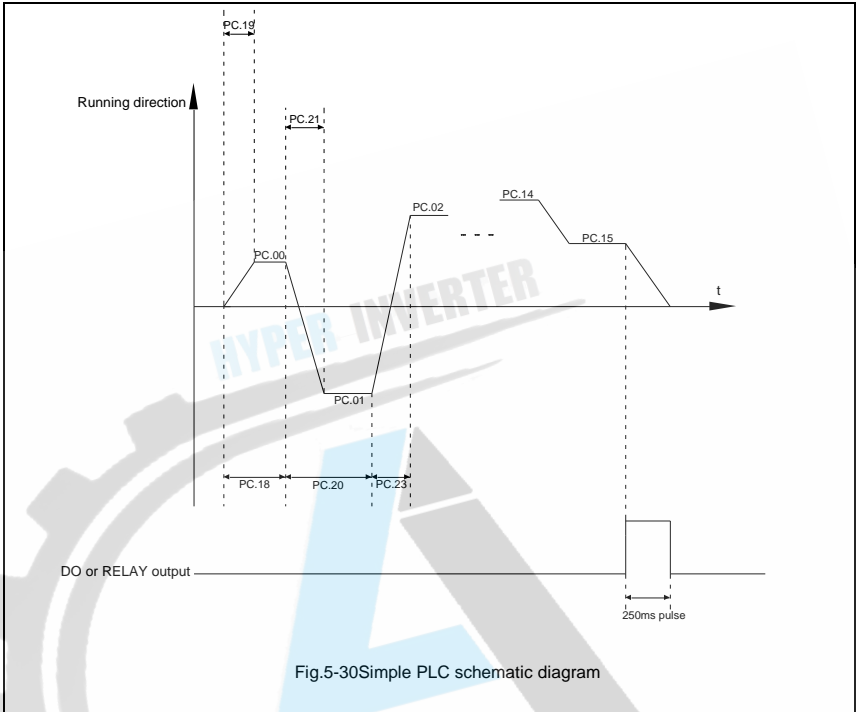

Fig.5-30 Simple PLC schematic diagram

PC.17	PLC power off memory selection	1bit	Power off memory selection	00	☆	
			Power off without memory			0
			Power off with memory			1
		10bit	Stop memory selection			
			Stop without memory			0
			Stop with memory			1
<p>PLC power off memory refers to memorizing the PLC running stage and running frequency before power off, and continues to run from the memory stage upon next power-on. If 1bit is set to 0, PLC process would restart upon power-on.</p> <p>PLC stop memory refers to the record of PLC running stage and running frequency of the time before. Next time PLC continues to run from the memory stage. If 10bit is set to 0, PLC process would restart upon power-on.</p>						
PC.18	PLC 0segment running time	0.0s(h) ~ 6553.5s(h)		0.0s(h)	☆	
PC.19	PLC 0segment acc./dec. time	0~3		0	☆	

Section V. Parameter Function Table

PC.20	PLC 1segment running time	0.0s(h)~6553.5s(h)	0.0s(h)	☆
PC.21	PLC 1segment acc./dec. time	0~3	0	☆
PC.22	PLC 2segment running time	0.0s(h)~6553.5s(h)	0.0s(h)	☆
PC.23	PLC 2segment acc./dec. time	0~3	0	☆
PC.24	PLC 3segment running time	0.0s(h)~6553.5s(h)	0.0s(h)	☆
PC.25	PLC 3segment acc./dec. time	0~3	0	☆
PC.26	PLC 4segment running time	0.0s(h)~6553.5s(h)	0.0s(h)	☆
PC.27	PLC 4segment acc./dec. time	0~3	0	☆
PC.28	PLC 5 segment running time	0.0s(h)~6553.5s(h)	0.0s(h)	☆
PC.29	PLC 5segment acc./dec. time	0~3	0	☆
PC.30	PLC 6segment running time	0.0s(h)~6553.5s(h)	0.0s(h)	☆
PC.31	PLC 6segment acc./dec. time	0~3	0	☆
PC.32	PLC 7segment running time	0.0s(h)~6553.5s(h)	0.0s(h)	☆
PC.33	PLC 7segment acc./dec. time	0~3	0	☆
PC.34	PLC 8segment running time	0.0s(h)~6553.5s(h)	0.0s(h)	☆
PC.35	PLC 8segment acc./dec. time	0~3	0	☆
PC.36	PLC 9segment running time	0.0s(h)~6553.5s(h)	0.0s(h)	☆
PC.37	PLC 9segment acc./dec. time	0~3	0	☆
PC.38	PLC 10segment running time	0.0s(h)~6553.5s(h)	0.0s(h)	☆
PC.39	PLC 10segment acc./dec.time	0~3	0	☆
PC.40	PLC 11segment running time	0.0s(h)~6553.5s(h)	0.0s(h)	☆
PC.41	PLC 11segment acc./dec. time	0~3	0	☆
PC.42	PLC 12segment running time	0.0s(h)~6553.5s(h)	0.0s(h)	☆
PC.43	PLC 12segment acc./dec. time	0~3	0	☆
PC.44	PLC 13segment running time	0.0s(h)~6553.5s(h)	0.0s(h)	☆
PC.45	PLC 13segment acc./dec. time	0~3	0	☆
PC.46	PLC 14segment running time	0.0s(h)~6553.5s(h)	0.0s(h)	☆

Section V. Parameter Function Table

PC.47	PLC 14segment acc./dec. time	0~3		0	☆
PC.48	PLC 15segment running time	0.0s(h)~6553.5s(h)		0.0s(h)	☆
PC.49	PLC 15segment acc./dec. time	0~3		0	☆
PC.50	Running time unit	S(second)	0	0	☆
		H(hour)	1		
PC.51	MS command 0 reference mode	Function code PC.00 reference	0	0	☆
		AI1	1		
		AI2	2		
		AI3(Potentiometer)	3		
		PULSE	4		
		PID	5		
		Preset frequency(P0.08) reference, UP/DOWN can be modified	6		

It is used to select the reference channel of MS speed 0.

Besides choosing PC.00, MS command 0 has many other options, which is convenient for switching between MS command and other set modes.

Both MS command and simple PLC used as frequency source can easily realize switching between the two frequency sources.

5-15 Communication function group: Pd.00-Pd.06

Please refer to 《DSI-400communication protocol》

Code	Description/ Keyboard Display	Setting Range		Factory Setting	Change Limit
		1bit	MODBUS		
Pd.00	Baud rate	300BPS	0	6005	☆
		600BPS	1		
		1200BPS	2		
		2400BPS	3		
		1bit	MODBUS		

Section V. Parameter Function Table

		4800BPS	4			
		9600BPS	5			
		19200BPS	6			
		38400BPS	7			
		57600BPS	8			
		115200BPS	9			
		10bit	Profibus-DP			
		115200BPS	0			
		208300BPS	1			
		256000BPS	2			
		512000BPS	3			
		100 bit	Reserved			
		1000 bit	Reserved			
Pd.01	Data format	Without calibration (8-N-2)	0	0	☆	
		Even parity calibration(8-E-1)	1			
		Uneven parity calibration(8-O-1)	2			
		8-N-1	3			
Pd.02	Local address	1-247, 0 is broadcast address	1		☆	
Pd.03	Response delay	0ms-20ms	2		☆	
Pd.04	Excessive communication	0.0(invalid), 0.1s-60.0s	0.0		☆	

Section V. Parameter Function Table

	time						
Pd.05	Data transform selection	1bit	MODBUS	0	31	☆	
		Non-standard MODBUS protocol					1
		Standard MODBUS protocol					0
		10 bit	Profibus-DP	0			
		PPO1 format					1
		PPO2 format					2
		PPO3 format					3
		PPO5 format		0			
Pd.06	Communication read current resolution	0.01A		0	0	☆	
		0.1A		1			

5-16 User customization function code: PE.00-PE.29

Code	Description/ Keyboard Display	Setting Range	Factory Setting	Change Limit
PE.00	User function code 0	P0.00~PP:xx,A0.00~Ax.xx,U0.xx	P0.01	☆
PE.01	User function code 1	P0.00~PP:xx,A0.00~Ax.xx,U0.xx	P0.02	☆
PE.02	User function code 2	P0.00~PP:xx,A0.00~Ax.xx,U0.xx	P0.03	☆
PE.03	User function code 3	P0.00~PP:xx,A0.00~Ax.xx,U0.xx	P0.07	☆
PE.04	User function code 4	P0.00~PP:xx,A0.00~Ax.xx,U0.xx	P0.08	☆
PE.05	User function code 5	P0.00~PP:xx,A0.00~Ax.xx,U0.xx	P0.17	☆
PE.06	User function code 6	P0.00~PP:xx,A0.00~Ax.xx,U0.xx	P0.18	☆
PE.07	User function code 7	P0.00~PP:xx,A0.00~Ax.xx,U0.xx	P3.00	☆
PE.08	User function code 8	P0.00~PP:xx,A0.00~Ax.xx,U0.xx	P3.01	☆
PE.09	User function code 9	P0.00~PP:xx,A0.00~Ax.xx,U0.xx	P4.00	☆

Section V. Parameter Function Table

PE.10	User function code 10	P0.00-PP:xx,A0.00~Ax.xx,U0.xx	P4.01	☆
PE.11	User function code 11	P0.00-PP:xx,A0.00~Ax.xx,U0.xx	P4.02	☆
PE.12	User function code 12	P0.00-PP:xx,A0.00~Ax.xx,U0.xx	P5.04	☆
PE.13	User function code 13	P0.00-PP:xx,A0.00~Ax.xx,U0.xx	P5.07	☆
PE.14	User function code 14	P0.00-PP:xx,A0.00~Ax.xx,U0.xx	P6.00	☆
PE.15	User function code 15	P0.00-PP:xx,A0.00~Ax.xx,U0.xx	P6.10	☆
PE.16	User function code 16	P0.00-PP:xx,A0.00~Ax.xx,U0.xx	P0.00	☆
PE.17	User function code 17	P0.00-PP:xx,A0.00~Ax.xx,U0.xx	P0.00	☆
PE.18	User function code 18	P0.00-PP:xx,A0.00~Ax.xx,U0.xx	P0.00	☆
PE.19	User function code 19	P0.00-PP:xx,A0.00~Ax.xx,U0.xx	P0.00	☆
PE.20	User function code 20	P0.00-PP:xx,A0.00~Ax.xx,U0.xx	P0.00	☆
PE.21	User function code 21	P0.00-PP:xx,A0.00~Ax.xx,U0.xx	P0.00	☆
PE.22	User function code 22	P0.00-PP:xx,A0.00~Ax.xx,U0.xx	P0.00	☆
PE.23	User function code 23	P0.00-PP:xx,A0.00~Ax.xx,U0.xx	P0.00	☆
PE.24	User function code 24	P0.00-PP:xx,A0.00~Ax.xx,U0.xx	P0.00	☆
PE.25	User function code 25	P0.00-PP:xx,A0.00~Ax.xx,U0.xx	P0.00	☆
PE.26	User function code 26	P0.00-PP:xx,A0.00~Ax.xx,U0.xx	P0.00	☆
PE.27	User function code 27	P0.00-PP:xx,A0.00~Ax.xx,U0.xx	P0.00	☆
PE.28	User function code 28	P0.00-PP:xx,A0.00~Ax.xx,U0.xx	P0.00	☆
PE.29	User function code 29	P0.00-PP:xx,A0.00~Ax.xx,U0.xx	P0.00	☆

This function group is the user customization function code.

Users can put the required parameters (among all DSI-400 function codes) to the PE group as the user customization function group.

PE group can offer 30 user customization function codes at most. When PE displays P0.00, it means user function code is null.

In user customization function mode, display of the function codes is defined through PE.00~PE.31. Sequence is consistent with the PE function codes, skip P0.00.

5-17 Function code management: PP.00-PP.04

Code	Description/ Keyboard Display	Setting Range	Factory Setting	Change Limit	
PP.00	User password	0-65535	0	☆	
<p>The password set function is used to prohibit the unauthorized person from viewing and modifying the parameters.</p> <p>When the parameter is set to any non-zero number, the password protection function is enabled. If no password is needed, change the parameter value to 00000.</p> <p>After the user password is set and takes effect, when entering the password setting state, if the user password is incorrect, you cannot view and modify the parameter. You can only view the operation display parameters and stop displaying parameters.</p> <p>Please keep your password in mind. If you set the password mistakenly or forget the password, please contact the manufacturer.</p>					
PP.01	Parameter initialization	No function	0	0	★
		Restore to factory default value,motor parameter not included	1		
		Clear memory	2		
		Restore factory parameters, Including motor parameters	3		
		Backup user current parameter	4		
		Restore user backup parameter	501		
<p>0: No function.</p> <p>1: Restore to factory default value,motor parameter not included</p> <p>The inverter restores all the parameters excluding the following parameters of the factory default values:</p> <p>Motor parameters, P0.22, fault record information, P7.09, P7.13, P7.14.</p> <p>2: Clear memory</p> <p>The inverter clears the fault records , P7.09, P7.13 and P7.14 to zero.</p> <p>3: Restore factory parameters, Including motor parameters</p> <p>PP.01=3, The inverter restores all the parameters excluding the following parameters of the factory</p>					

Section V. Parameter Function Table

default values

4: Backup user current parameter

It is the backup of user current setting parameters, which is convenient for the user to restore the disordered parameters .

501: Restore user backup parameter

It is used to restore the backup of user parameters, that is, restore the backup parameters which is set through PP.01=501.

PP.02	Parameter display attribute	1bit	U group display selection	11	★	
		No display				0
		Display				1
		10bit	A group display selection			
		No display				0
		Display				1
PP.03	Personalized parameter display selection	1bit	Custom parameter display selection	00	☆	
		No display				0
		Display				1
		10bit	User change parameter display selection			
		No display				0
		Display				1

The establishment of parameter display selection is basically convenient for the users viewing the different arrangement forms of function parameters according to the actual needs. Three display methods are offered as below:

Name	Description
Function parameter mode	Sequence display inverter function parameters, respectively P0~PF、A0~AF、U0~UF.
User customization parameter mode	User customization display of specified function parameters(32 at most). The display parameters is determined through PE group.
User change parameter mode	Parameters which are different from factory default.

When existing display for PP.03, user could switch into different display mode through QUICK key.

Section V. Parameter Function Table

Function parameter display mode as default.

Parameter display mode	Display
Function parameter mode- FunC	-FunC
User customization parameter mode-USEt	-USER
User change parameter mode-U--C	-U--C

Display codes as below:

DSI-400 series offers two groups of personalized parameter display mode: user customization function mode, user change parameter mode.

In user customization parameter mode, sign u is added to the user customization function code as default.

In user change parameter mode, sign c is added to the user customization function code as default. E.g: P1.00 is displayed as cP1.00 .

PP.04	Function codes modification attribute	Can be modified	0	0	☆
		Can not be modified	1		
<p>This function is used to prevent misoperation of the function parameters.</p> <p>PP.04=0: All the function codes can be modified.</p> <p>PP.04=1: All the function codes can only be viewed, but not modified.</p>					

5-18 Torque control group: A0.00-A0.08

Code	Description/ Keyboard Display	Setting Range		Factory Setting	Change Limit
A0.00	Speed/ torque control mode selection	Speed control	0	0	★
		Torque control	1		
<p>A0.00 is used to select inverter control mode: speed control or torque control.</p> <p>Multi-function digit DI terminal of DSI-400 is equipped with two functions relating torque control: Torque control banned(Function29), speed control/torque control switching (function 46). The two terminals should be matched with A0.00 to realize switching between speed control and torque control.</p> <p>A0.00 set the control mode when speed/torque control switching terminal invalid. If the speed/torque control switching terminal is valid, control mode is equivalent to the inversion of A0.00 value.</p>					

Section V. Parameter Function Table

When function 29 is valid, speed control mode is fixed for the inverter .					
A0.01	Torque setup source selection in torque control mode	Digital setup(A0.03)	0	0	★
		AI1	1		
		AI2	2		
		AI3(Potentiometer)	3		
		PULSE	4		
		Communication setup	5		
		MIN(AI1,AI2)	6		
		MAX(AI1,AI2)	7		
A0.03	Torque digital setup in torque control mode	-200.0%~200.0%	150%	☆	
<p>A0.01 is used to select torque set source. There are totally 8 kinds of torque set mode.</p> <p>Torque set is a relative value, which 100% corresponding to inverter rated torque. Set range: 200.0%~200.0%.Maximum torque is 2 times that of inverter rated torque</p> <p>When the torque is set by selection 1~7, 100% of communication ,analog input, pulse input corresponding to A0.03.</p>					
A0.05	Torque control forward maximum frequency	0.00Hz~Maximum frequency(P0.10)	50.00Hz	☆	
A0.06	Torque control Reserved maximum frequency	0.00Hz~Maximum frequency(P0.10)	50.00Hz	☆	
<p>A0.05, A0.06 are used to set forward or Reserved maximum running frequency in torque control mode.</p> <p>In inverter torque control mode, if load torque is less than motor output torque, the motor revolving speed would speed up. In case of galloping or other accidents of mechanical system , motor maximum revolving speed must be limited.</p>					
A0.07	Torque control acc. time	0.00s~65000s	0.00s	☆	
A0.08	Torque control dec. time	0.00s~65000s	0.00s	☆	
<p>In torque control mode , rate of speed change of motor and load is decided by the difference between motor output torque and load torque. Therefore, motor speed may change fast, causing noise or excessive mechanical stress problems. By setting the torque control acc./dec. time, can make the motor speed changes smoothly.</p> <p>A0.07 and A0.08 should be set to 0.00s in situations where torque rapid response is needed.</p>					

Section V. Parameter Function Table

E.g: Two motors drive the same load, to make sure of load uniform distribution , one is set as host inverter(speed control mode) and another is the slave one(torque control mode). Actual output torque of the host inverter is the torque command of the slave, and slave torque is required to quickly follow the host torque, then torque control acc./dec. time is set to 0.00s for the slave inverter.

5-19 Virtual IO: A1.00-A1.21

Code	Description/ Keyboard Display	Setting Range	Factory Setting	Change Limit		
A1.00	Virtual VDI1 function selection	0~59	0	★		
A1.01	Virtual VDI2 function selection	0~59	0	★		
A1.02	Virtual VDI3 function selection	0~59	0	★		
A1.03	Virtual VDI4 function selection	0~59	0	★		
A1.04	Virtual VDI5 function selection	0~59	0	★		
Functions of virtual VDI1~VDI5 are equal to DI terminals on control board. VDI1~VDI5 can be used as multi-function digital input terminals, for details please refer to description of P4.00~P4.09 .						
A1.05	Virtual VDI terminal valid state set mode	1bit	Virtual VDI1		00000	★
		State of virtual VYx decides whether VDI is effective		0		
		Function code A1.06 decide whether VDI is effective		1		
		10bit	Virtual VDI2			
		State of virtual VYx decides whether VDI is effective		0		
		Function code A1.06 decides whether VDI is effective		1		
		100 bit	Virtual VDI3			
		State of virtual VDOx decides whether VDI is effective		0		
		Function code A1.06 decides whether VDI is effective		1		
		1000 bit	Virtual VDI4			

Section V. Parameter Function Table

		State of virtual VDOx decides whether VDI is effective	0		
		Function code A1.06 decides whether VDI is effective	1		
		10000 bit	Virtual VDI5		
		State of virtual VDOx decides whether VDI is effective	0		
		Function code A1.06 decides whether VDI is effective	1		
A1.06	Virtual VD1 terminal state	1bit	Virtual VDI1	00000	★
		Invalid	0		
		Valid	1		
		10bit	Virtual VDI2		
		Invalid	0		
		Valid	1		
		100bit	Virtual VDI3		
		Invalid	0		
		Valid	1		
		1000 bit	Virtual VDI4		
		Invalid	0		
		Valid	1		
		10000 bit	Virtual VDI5		

Section V. Parameter Function Table

		Invalid	0	
		Valid	1	
<p>State of virtual VDI terminal can be set through 2 setting methods, which is different from common digit input terminals, and select through A1.05.</p> <p>When choosing the corresponding VDO state as the decision of VDI state , valid state of VDI is depending on VDO output as valid or not. VDIx only binding VDOx(x : 1~5).</p> <p>Binary bits of function code A1.06 decide virtual input terminal states respectively.</p> <p>The following example illustrates the method of using virtual VDI.</p> <p>E.g1: When choosing VDO state deciding VDI state, to complete "AI1 input exceeding limit, inverter fault alarm and stop":</p> <p>Set VDI1 to " user-defined fault 1"(A1.00=44);</p> <p>Set VDO1 (A1.05=xxx0) to decide VDI1 terminal valid state;</p> <p>Set VDO1 output function to "AI1 excessive input"(A1.11=31);</p> <p>When AI1 exceeding the upper / lower limit , VDO1 output ON signal, VDI1 input terminal state is valid, VDI1 receives " user-defined fault 1", and inverter fault alarm and stop , fault No. 27= E.US11.</p> <p>E.g2: When choosing function code A1.06 deciding VDI state, to complete " Auto into running state after power-on ":</p> <p>Set VDI1 to "Forward command FWD"(A1.00=1);</p> <p>Set function code (A1.05=xxx1) to decide VDI1 terminal valid state;</p> <p>Set VDI1 terminal to valid state(A1.06=xxx1);</p> <p>Set command source to "Terminal control"(P0.02=1);</p> <p>Set startup protection selection to invalid state.(P8.18=0);</p> <p>After inverter power-on and the initialization, VDI1 is detected as valid, the terminal corresponding to forward running, which is equivalent to inverter receiving a forward running command, and then start forward running.</p>				
A1.07	AI1 as DI function selection	0~59	0	★
A1.08	AI2 as DI function selection	0~59	0	★

Section V. Parameter Function Table

A1.09	AI3 as DI function selection	0~59		0	★	
A1.10	AI as DI valid mode selection	1bit	AI1	000	★	
		High level valid				0
		Low level valid				1
		100bit	AI2			
		High level valid				0
		Low level valid				1
		1000 bit	AI3(Potentiometer)			
		High level valid				0
Low level valid		1				
<p>AI is used as DI for this function group. AI input voltage is greater than 7V, corresponding AI terminal state is high level. AI input voltage is less than 3V, corresponding AI terminal state is low level. 3V~7V for hysteresis loop .</p> <p>Whether AI (as DI) high level valid or low level valid is determined through function code A1.10. For AI(as DI) function settings, they are same with common DI settings, for details please refer to P4 group .</p> <p>Fig. 5-31 takes AI input voltage as an example, explains the relationship between AI input voltage and corresponding DI state:</p>						

Section V. Parameter Function Table

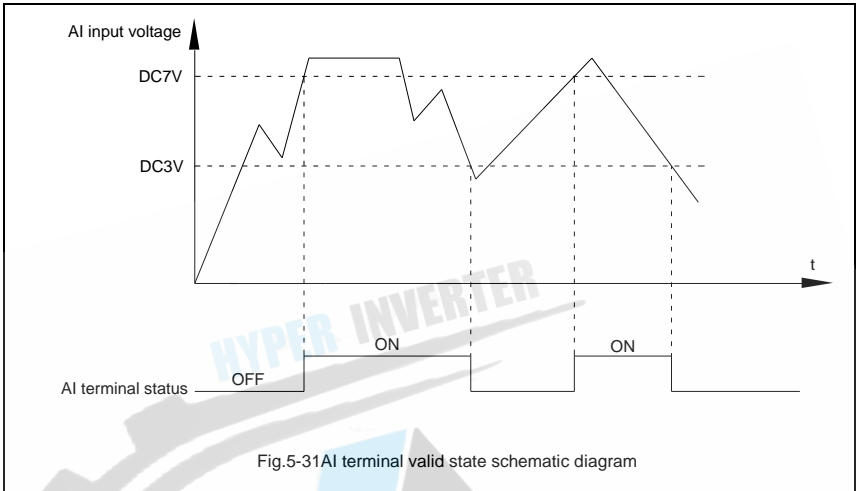

A1.11	Virtual VDO1 output function	Short circuit with physics DIx internals	0	0	☆
		See P5 group for physics DO output selection	1~40		
A1.12	Virtual VDO2 output function	Short circuit with physics DIx internals	0	0	☆
		See P5 group for physics DO output selection	1~40		
A1.13	Virtual VDO3 output function	Short circuit with physics DIx internals	0	0	☆
		See P5 group for physics DO output selection	1~40		
A1.14	Virtual VDO4 output function	Short circuit with physics DIx internals	0	0	☆
		See P5 group for physics DO output selection	1~40		
A1.15	Virtual VDO5 output function	Short circuit with physics DIx internals	0	0	☆
		See P5 group for physics DO output selection	1~40		
A1.16	VDO1 output delay time	0.0s~3600.0s		0.0s	☆

Section V. Parameter Function Table

A1.17	VDO2 output delay time	0.0s~3600.0s		0.0s	☆	
A1.18	VDO3 output delay time	0.0s~3600.0s		0.0s	☆	
A1.19	VDO4 output delay time	0.0s~3600.0s		0.0s	☆	
A1.20	VDO5 output delay time	0.0s~3600.0s		0.0s	☆	
A1.21	VDO output terminal valid state selection	1bit	VDO1	00000	☆	
		Positive logic				0
		Negative logic				1
		10bit	VDO2			
		Positive logic				0
		Negative logic				1
		100bit	VDO3			
		Positive logic				0
		Negative logic				1
		1000 bit	VDO4			
		Positive logic				0
		Negative logic				1
		10000 bit	VDO5			
		Positive logic				0
Negative logic		1				
<p>Virtual digit output function , which is similar with control board DO output function , can be used to cooperate with virtual digit input VDlx, to realize some simple logic control.</p>						

When virtual VDOx output function selecting 0, VDO1~VDO5 output states is determined by input states of DI1~DI5 on the keyboard.VDOx and DIx one-to-one corresponding.

When virtual VDOx output function selecting non-zero digits, VDOx function setting and use method are same with P5 group DO output relevant parameters, for details please refer to P5 group.

Similarly, VDOx output valid state can choose positive or negative logic, and set through A1.21.

For VDOx use reference , please refer to applications for VDIx use .

5-20 The second motor control: A2.00-A2.65

DSI-400 can switch operation between 4 motors. The 4 motors could set motor nameplate parameters, tune motor parameters, use V/F control or vector control, set encoder relating parameters and set V/F control or vector control relating parameters respectively.

Groups of A2、 A3、 A4 are corresponding to motor2、 motor3、 motor4 respectively. And the layout of the 3 groups of function codes are completely consistent .

For details please refer to relating parameters of motor1.

Code	Description/ Keyboard Display	Setting Range		Factory Setting	Change Limit
A2.00	Motor type selection	General asynchronous motor	0	0	★
		Variable frequency asynchronous motor	1		
		Permanent magnet synchronous motor	2		
A2.01	Rated power	0.1kW~1000.0kW		-	★
A2.02	Rated voltage	1V~2000V		-	★
A2.03	Rated current	0.01A~655.35A(Inverter power <=55kW)		-	★
		0.1A~6553.5A(Inverter power >55kW)			
A2.04	Rated frequency	0.01Hz~maximum frequency		-	★
A2.05	Rated revolving speed	1rpm~65535rpm		-	★
A2.06	Asynchronous motor stator resistance	0.001Ω~65.535Ω(Inverter power <=55kW)		-	★
		0.0001Ω~6.5535Ω(Inverter power >55kW)			
A2.07	Asynchronous motor rotor resistance	0.001Ω~65.535Ω(Inverter power <=55kW)		-	★
		0.0001Ω~6.5535Ω(Inverter power >55kW)			
A2.08	Asynchronous motor leakage	0.01mH~655.35mH(Inverter power <=55kW)		-	★

Section V. Parameter Function Table

	inductance	0.001mH~65.535mH(Inverter power >55kW)			
A2.09	Asynchronous motor mutual inductance	0.1mH~6553.5mH(Inverter power <=55kW) 0.01mH~655.35mH(Inverter power >55kW)		-	★
A2.10	Asynchronous motor no load current	0.01A~A2.03(Inverter power <=55kW) 0.1A~A2.03(Inverter power >55kW)		-	★
A2.27	Encoder pulses number	1~65535		2500	★
A2.28	Encoder type	ABZ incremental encoder	0	0	★
		UVW incremental encoder	1		
		Rotary transformer	2		
		Sine/cosine encoder	3		
		UVW encoder	4		
A2.29	Speed feedback PG selection	Local PG	0	0	★
		Expansion PG	1		
		PULSE pulse input(DI5)	2		
A2.30	ABZ incremental encoder AB phase	Forward	0	0	★
		Reserve	1		
A2.31	Encoder installation angle	0.0°~359.9°		0	★
A2.32	UVW phase sequence	Forward	0	0	★
		Reserved	1		
A2.33	UVW encoder offset angle	0.0°~359.9°		0.00	★
A2.34	Rotary transformer pole pairs	1~65535		1	★
A2.36	PG dropped inspection time	No action	0.0s	0.0s	★
		0.1s~10.0s	0.1s		
A2.37	Tuning selection	No operation	0	0	★
		Asynchronous static tuning	1		
		Asynchronous complete tuning	2		
		Synchronous static tuning	11		

Section V. Parameter Function Table

		Synchronous complete tuning		12		
A2.38	Speed loop proportional gain 1	1~100			30	☆
A2.39	Speed loop integration time1	0.01s~10.00s			0.50s	☆
A2.40	Switching frequency1	0.00~A2.43			5.00Hz	☆
A2.41	Speed loop proportional gain 2	0~100			20	☆
A2.42	Speed loop integration time 2	0.01s~10.00s			1.00s	☆
A2.43	Switching frequency 2	A2.40~maximum output frequency			10.00Hz	☆
A2.44	Vector control slip gain	50%~200%			150%	☆
A2.45	Speed-loop filtering time	0.000s~0.100s			0.000s	☆
A2.47	Torque upper limit source in speed control mode	A2.48 setup		0	0	☆
		AI1		1		
		AI2		2		
		AI3(Potentiometer)		3		
		PULSE setup		4		
		Communication setup		5		
		MIN(AI1,AI2)		6		
		MAX(AI1,AI2)		7		
A2.48	Torque upper limit digital setup in speed control mode	0.0%~200.0%			150.0%	☆
A2.51	Excitation regulation proportional gain	0~60000			2000	☆
A2.52	Excitation regulation integration gain	0~60000			1300	☆
A2.53	Torque regulation proportional gain	0~60000			2000	☆
A2.54	Torque regulation integration gain	0~60000			1300	☆
A2.55	Speed loop integration attribute	1bit	Integration separation		0	☆
		Invalid		0		

Section V. Parameter Function Table

		Valid	1		
A2.61	Motor2 control mode	Speed sensorless vector control(SVC)	0	0	★
		Speed sensor vector control(FVC)	1		
		V/F control	2		
A2.62	Motor 2 acc./dec. time selection	Same with the first motor	0	0	☆
		Acceleration time1	1		
		Acceleration time 2	2		
		Acceleration time 3	3		
A2.63	Motor 2 torque hoist	Auto torque hoist	0.0%	-	☆
		0.1%~30.0%			
A2.65	Motor 2 oscillation suppression gain	0~100		-	☆

5-21 Control optimization: A5.00-A5.11

Code	Description/ Keyboard Display	Setting Range	Factory Setting	Change Limit	
A5.00	DPWM switching frequency upper limit	0.00Hz~15.00Hz	8.00Hz	☆	
<p>A5.00 is only valid for VF control mode. In asynchronous motor VF running mode, square wave determine the continuous modulation mode. Wave value < A5.00: 7-stage continuous modulation mode. Wave value > A5.00: 5-stage continuous modulation mode.</p> <p>In 7-stage continuous modulation mode, inverter switch loss is relatively big, but current ripple is small. In 5-stage continuous modulation mode, inverter switch loss is relatively small, but current ripple is big. High frequency may lead to motor operation instability, generally there is no need of modification.</p> <p>For VF operation instability please refer to P3.11. For inverter loss and temperature rise please refer to P0.15.</p>					
A5.01	PWM modulation mode	Asynchronous modulation	0	0	☆
		Synchronous modulation	1		
<p>This parameter is only valid for VF control mode. Asynchronous modulation refers to carrier frequency that linear changes with output frequency, and ensure that the ratio of them (carrier ratio) remains the same. Generally high output frequency is benefit for output voltage quality.</p> <p>Generally, synchronous modulation is not needed at low frequencies (below 100Hz), because the</p>					

Section V. Parameter Function Table

<p>ratio of carrier frequency and output frequency is relatively high, asynchronous modulation advantage is more obvious.</p> <p>When running frequency is greater than 85Hz, synchronous modulation is valid. And fixed as asynchronous modulation mode when below this frequency.</p>					
A5.02	Dead-zone compensation mode selection	No compensation	0	1	☆
		Compensation mode 1	1		
<p>Generally speaking , A5.02 needs not to be modified. Only when the output voltage waveform quality has special requirements or motor appears abnormal phenomenon would users switch the compensation mode.</p>					
A5.03	Random PWM depth	Random PWM invalid	0	0	☆
		PWM carrier frequency random depth	1~10		
<p>Set the random PWM, monotonous and harsh electromagnetic noise can be changed to the heterogeneous and soft, the external electromagnetic interference can be effectively reduced. 0 indicates that the PWM is invalid. Different random PWM depth represents different regulation effect.</p>					
A5.04	Rapid current-limiting enable	Invalid	0	1	☆
		Valid	1		
<p>Enable the rapid current-limiting function so as to minimize inverter overcurrent protection fault and make the inverter work normally.</p> <p>If the inverter long time continuous staying in rapid current-limiting state, it may occur overheating fault, which is not allowed during operation. Fault alarm of long time rapid current-limiting is 40= Err40 , which refers to inverter overload and necessary stop.</p>					
A5.05	Voltage over modulation coefficient	100~110%		105	★
A5.06	Under-voltage point setup	210-420		350	☆
<p>A5.06 is used to set value of inverter under-voltage fault 9= Err09.</p>					
A5.08	Low speed carrier frequency	0.0-8.0khz		0.0	☆
A5.09	Over voltage point setup	200.0V~2500.0V		810.0V	★
<p>A5.09 is over voltage point set through software, which is not related to hardware over voltage point.</p>					
A5.11	Dc injection braking	0.00~5.00hz		0.30hz	☆

Section V. Parameter Function Table

	threshold at low speed			
--	------------------------	--	--	--

5-22 AI curve setup: A6.00-A6.29

Code	Description/ Keyboard Display	Setting Range	Factory Setting	Change Limit
A6.00	AI curve 4 minimum input	-10.00V~A6.02	0.00V	☆
A6.01	AI curve 4 minimum input corresponding setup	-100.0%~100.0%	0.0%	☆
A6.02	AI curve 4 inflection point 1 input	A6.00~A6.04	3.00V	☆
A6.03	AI curve 4 inflection point 1 input corresponding setup	-100.0%~100.0%	30.0%	☆
A6.04	AI curve 4 inflection point 2 input	A6.02~A6.06	6.00V	☆
A6.05	AI curve 4 inflection point 2 input corresponding setup	-100.0%~100.0%	60.0%	☆
A6.06	AI curve 4 maximum input	A6.06~10.00V	10.00V	☆
A6.07	AI curve 4 maximum input corresponding setup	-100.0%~100.0%	100.0%	☆
A6.08	AI curve 4 minimum input	-10.00V~A6.10	-10.00V	☆
A6.09	AI curve 5 minimum input corresponding setup	-100.0%~100.0%	-100.0%	☆
A6.10	AI curve 5 inflection point 1 input	A6.08~A6.12	-3.00V	☆
A6.11	AI curve 5 inflection point 1 input corresponding setup	-100.0%~100.0%	-30.0%	☆
A6.12	AI curve 5 inflection point 2 input	A6.10~A6.14	3.00V	☆
A6.13	AI curve 5 inflection point 2 input corresponding setup	-100.0%~100.0%	30.0%	☆
A6.14	AI curve 5 maximum input	A6.12~10.00V	10.00V	☆
A6.15	AI curve 5 maximum input	-100.0%~100.0%	100.0%	☆

Section V. Parameter Function Table

	corresponding setup			
--	---------------------	--	--	--

Function of curve 4 and curve 5 are similar with curve 1~curve 3's. Curve 1~curve 3 are straight lines, while curve 4 and curve 5 are 4-point curves which could realize more flexible correspondence.

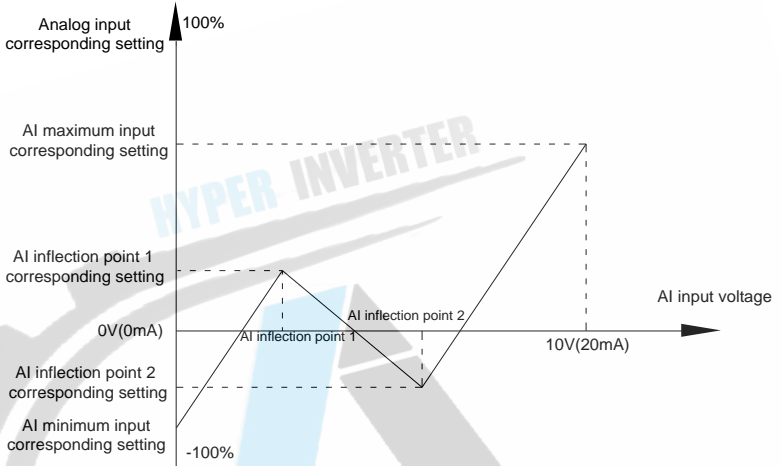

Fig.5-32Curve4 and curve 5 schematic diagram

Notice: When setting curve 4 and curve 5, minimum input voltage, inflection point 1 voltage, inflection point 2 voltage and maximum voltage must be increased in turn.

A6.24	AI1 set hopping point	-100.0%~100.0%	0.0%	☆
A6.25	AI1 set hopping amplitude	0.0%~100.0%	0.5%	☆
A6.26	AI2 set hopping point	-100.0%~100.0%	0.0%	☆
A6.27	AI2 set hopping amplitude	0.0%~100.0%	0.5%	☆
A6.28	AI3 set hopping point	-100.0%~100.0%	0.0%	☆
A6.29	AI3 set hopping amplitude	0.0%~100.0%	0.5%	☆

Analog input AI1~AI3 of DSI-400 are all provided with hopping function for set value.

Hopping frequency refers to fixing of analog corresponding setup to the value of hopping point when analog corresponding setting varies within jump point upper/lower limit.

E.g:

Voltage of analog input AI1 is in 5.00V fluctuation, which range is 4.90V~5.10V. Minimum input 0.00V corresponding to 0.0%, while maximum input 10.00V corresponding to 100.%. The corresponding setting of AI1 fluctuates between 49.0%~51.0%.

Section V. Parameter Function Table

Set A5.16 to 50.0% and A5.17 to 1.0%, after hopping function processing, AI1 is fixed as 50.0%. In this way, AI1 is converted into a stable input, and fluctuation is eliminated.

5-23 User programmable card parameters: A7.00-A7.09

Code	Description/ Keyboard Display	Setting Range		Factory Setting	Change Limit	
A7.00	User programmable function selection	Invalid		0	★	
		Valid				
A7.01	Control board output terminal control mode selection	Inverter control		0	-	
		User programmable card control		1		
		1bit	FMP(Y1 as pulse output)			★
		10bit	Relay(T/A1-T/B1-T/C1)			
		100 bit	DO1			
		1000 bit	FMR(Y1 as switch output)			
10000 bit	AO1					
A7.02				-	★	
A7.03	FMP output	0.0%-100.0%		0.0%	☆	
A7.04	AO1 output	0.0%-100.0%		0.0%	☆	
A7.05	Switch output	1bit	FMR	000	☆	
		10bit	Relay 1			
		100 bit	DO			
A7.06	Programmable card frequency setup	0.0%-100.0%		0.0%	☆	
A7.07	Programmable card torque setup	-200.0%-200.0%		0.0%	☆	

Section V. Parameter Function Table

A7.08	Programmable card command setup	No command	0	0	☆
		Forward command	1		
		Reserved command	2		
		Forward jog	3		
		Reserved jog	4		
		Free stop	5		
		Decelerate to stop	6		
		Fault reset	7		
A7.09	Programmable card fault setup	No fault	0	0	☆
		Fault code	80-89		

5.24 Point to point communication: A8.00-8.11

Code	Description/ Keyboard Display	Setting Range		Factory Setting	Change Limit	
A8.00	Master slave control function selection	Invalid	0	0	☆	
		Valid	1			
A8.01	Master slave selection	Master	0	0	☆	
		slave	1			
A8.02	Master slave information exchange	0 bit	Do not follow the Master command	0	011	☆
			follow the Master command	1		
		10 bit	Do not send fault information	0		
			send fault information	1		
100 bit	Do not warning when slave off line	0				

Section V. Parameter Function Table

			warning when slave off line	1	
A8.03	Message frame selection	Master slave control frame		0	☆
		Droop control frame		1	
A8.04	Receive data zero offset torque	-100.00%~100.00%		0.00	★
A8.05	Receive data gain torque	-10.00~100.0		1.00	★
A8.06	Communication interrupt detection time	0.0s~10.0s		1.0s	☆
A8.07	Communication Master data transmission cycle	0.001s~10.000s		0.001	☆
A8.08	Receive data zero offset frequency	-100.00%~100.00%		0.00	★
A8.09	Receive data gain frequency	-10.00~100.00		1.00	★
A8.10	Reserved			-	
A8.11	view	0.20Hz~10.00Hz		0.5	★

5-25 Extended function group: A9.00-A9.09

Code	Description/ Keyboard Display	Setting Range	Factory Setting	Change Limit
A9.00	Reserved	Reserved	0	●
A9.01	Reserved	0~65535	0	☆
A9.02	Reserved	0~65535	0	☆
A9.03	Reserved	0~65535	0	☆
A9.04	Reserved	0~65535	0	☆
A9.05	Reserved	0~65535	0	☆

Section V. Parameter Function Table

A9.06	Reserved	0~65535	0	☆
A9.07	Reserved	0~65535	0	☆
A9.08	Reserved	0~65535	0	☆
A9.09	Reserved	0~65535	0	☆

5-26 AIAO correction: AC.00-AC.19

Code	Description/ Keyboard Display	Setting Range	Factory Setting	Change Limit
AC.00	AI1 measured voltage 1	0.500V~4.000V	Factory calibration	☆
AC.01	AI1 display voltage 1	0.500V~4.000V	Factory calibration	☆
AC.02	AI1 measured voltage 2	6.000V~9.999V	Factory calibration	☆
AC.03	AI1 display voltage 2	6.000V~9.999V	Factory calibration	☆
AC.04	AI2 measured voltage 1	0.500V~4.000V	Factory calibration	☆
AC.05	AI2 display voltage 1	0.500V~4.000V	Factory calibration	☆
AC.06	AI2 measured voltage 2	6.000V~9.999V	Factory calibration	☆
AC.07	AI2 display voltage 2	6.000V~9.999V	Factory calibration	☆
AC.08	AI3 measured voltage 1	-9.999V~10.000V	Factory calibration	☆
AC.09	AI3 display voltage 1	-9.999V~10.000V	Factory calibration	☆
AC.10	AI3 measured voltage 2	-9.999V~10.000V	Factory calibration	☆
AC.11	AI3 display voltage 2	-9.999V~10.000V	Factory calibration	☆

Section V. Parameter Function Table

This group of function codes are used for calibration of analog input AI , which could eliminate AI input bias and gain influence. Generally , there is no need of calibration in application, for it has been calibrated in factory. When restoring the factory value, the parameter would be restored to the default value of factory calibration.

Measured voltage refers to the actual voltage that has been measured through measuring instrument such as multimeter. Display voltage refers to the display value that has been sampled by the inverter. See U0 group (U0.21、U0.22、U0.23) display.

During calibration, put the multimeter measurement value and the U0 value respectively into the function codes above, inverter would automatically calibrate the AI zero off and gain.

AC.12	A01 target voltage 1	0.500V~4.000V	Factory calibration	☆
AC.13	A01 measured voltage 1	0.500V~4.000V	Factory calibration	☆
AC.14	A01 target voltage 2	6.000V~9.999V	Factory calibration	☆
AC.15	A01 measured voltage 2	6.000V~9.999V	Factory calibration	☆
AC.16	A02 target voltage 1	0.500V~4.000V	Factory calibration	☆
AC.17	A02 measured voltage 1	0.500V~4.000V	Factory calibration	☆
AC.18	A02 target voltage 2	6.000V~9.999V	Factory calibration	☆
AC.19	A02 measured voltage 2	6.000V~9.999V	Factory calibration	☆

This group of function codes are used for calibration of analog output AO. Generally , there is no need of calibration in application, for it has been calibrated in factory. When restoring the factory value, the parameter would be auto restored to the default value of factory calibration.

Target voltage refers to inverter theoretical output voltage, while measured voltage refers to the actual voltage that has been measured through measuring instrument such as multimeter.

Section VI. Fault Diagnosis & Solutions

DSI-400 is able to make full use of the device performance, while implementing effective protection. You may encounter following fault tips during operation, please control the following table analysis the possible causes, and rule out the fault.

-1 Fault alarm and solutions

DSI-400 series can not only make full use of equipment performance but also implement effective protection. DSI-400 series has 51 alarming information and protection function. Once fault occurs, protection function acts, output stops, inverter fault relay contact starts, and fault code is been displayed on the display panel. Before consulting the service department, the user can perform self-check according to the prompts of this chapter, analyze the fault cause and find out t solution. If the fault is caused by the reasons as described in the dotted frame, please consult the agents or our company directly.

Among the 51 items of warning information:

Fault no.22= Err22 refers to hardware over-current or over-voltage signal. In most cases hardware over-voltage fault led to fault no.22= Err22 alarming.

Fault name	Inverter unit protection
Panel display	Fault No.1= Err01
Fault investigation	<ol style="list-style-type: none"> 1、 Inverter output loop short circuit 2、 Two long wiring between motor and inverter. 3、 Module overheating 4、 Inverter internal wiring loose 5、 Main control board anomalies 6、 Drive board anomalies 7、 Inverter module anomalies
Fault countermeasures	<ol style="list-style-type: none"> 1、 Eliminate external faults 2、 Add reactor or output filter 3、 Check air duct, fan and eliminate existing problems. 4、 Insert all connecting wires 5、 For technical support

Fault name	Acceleration over current
Panel display	Fault No.2= Err02
Fault investigation	<ol style="list-style-type: none"> 1、 Acceleration time too short 2、 Improper manual torque boost or V/F curve 3、 Low voltage 4、 Inverter output loop grouded or short circuit 5、 Vector control mode without parameter identification 6、 Start the rotating motor 7、 Sudden load add in acceleration process 8、 Small type selection of inverter.
Fault countermeasures	<ol style="list-style-type: none"> 1、 Increase acceleration time 2、 Adjust manual torque boost or V/F curve 3、 Adjust voltage to normal range 4、 Eliminate external faults 5、 Parameter identification 6、 Select speed tracking start or restart after motor stop 7、 Cancel sudden added load 8、 Choose inverter of greater power level

Fault name	Deceleration over current
Panel display	Fault No.3= Err03
Fault investigation	<ol style="list-style-type: none"> 1、 Inverter output loop grouded or short circuit 2、 Vector control mode without parameter identification 3、 Deceleration time too short 4、 Low voltage

Section VI. Fault Diagnosis & Solutions

	<ul style="list-style-type: none"> 5、 Sudden load add in deceleration process 6、 No braking unit and brake resistance installed
Fault countermeasures	<ul style="list-style-type: none"> 1、 Eliminate external faults 2、 Parameter identification 3、 Increase deceleration time 4、 Adjust voltage to normal range 5、 Cancel sudden added load 6、 Install braking unit and brake resistance

Fault name	Constant speed over current
Panel display	Fault No.4= Err04
Fault investigation	<ul style="list-style-type: none"> 1、 Inverter output loop grounded or short circuit 2、 Vector control mode without parameter identification 3、 Low voltage 4、 Sudden load add in deceleration process 5、 Small type selection of inverter
Fault countermeasures	<ul style="list-style-type: none"> 1、 Eliminate external faults 2、 Parameter identification 3、 Adjust voltage to normal range 4、 Cancel sudden added load 5、 Choose inverter of greater power level

Fault name	Acceleration over voltage
Panel display	Fault No.5= Err05
Fault investigation	<ul style="list-style-type: none"> 1、 No braking unit and brake resistance installed 2、 High input voltage

Section VI. Fault Diagnosis & Solutions

	<ul style="list-style-type: none"> 3、 External force drive motor operation during acceleration process 4、 Acceleration time too short
Fault countermeasures	<ul style="list-style-type: none"> 1、 Install braking unit and brake resistance 2、 Adjust voltage to normal range 3、 Cancel external force or install brake resistance 4、 Increase acceleration time

Fault name	Deceleration over voltage
Panel display	Fault No.6= Err06
Fault investigation	<ul style="list-style-type: none"> 1、 High input voltage 2、 External force drive motor operation during deceleration process 3、 Deceleration time too short 4、 No braking unit and brake resistance installed
Fault countermeasures	<ul style="list-style-type: none"> 1、 Adjust voltage to normal range 2、 Cancel external force or install brake resistance 3、 Increase deceleration time 4、 Install braking unit and brake resistance

Fault name	Constant speed over voltage
Panel display	Fault No.7= Err07
Fault investigation	<ul style="list-style-type: none"> 1、 External force drive motor operation 2、 High input voltage
Fault countermeasures	<ul style="list-style-type: none"> 1、 Cancel external force or install brake resistance 2、 Adjust voltage to normal range

Section VI. Fault Diagnosis & Solutions

Fault name	Control power supply fault
Panel display	Fault No.8= Err08
Fault investigation	1、 Input voltage is not within the specified range
Fault countermeasures	1、 Adjust voltage to normal range

Fault name	Undervoltage fault
Panel display	Fault No.9= Err09
Fault investigation	<ol style="list-style-type: none"> 1、 Instantaneous power-off 2、 Input voltage is not within the specified range 3、 Bus voltage anomalies 4、 Rectifier and buffer resistance anomalies 5、 Drive board anomalies 6、 Control board anomalies
Fault countermeasures	<ol style="list-style-type: none"> 1、 Reset fault 2、 Adjust voltage to normal range 3、 For technical support

Fault name	Inverter overload
Panel display	Fault No.10= Err10
Fault investigation	<ol style="list-style-type: none"> 1、 Small type selection of inverter. 2、 Overload or motor stall
Fault countermeasures	<ol style="list-style-type: none"> 1、 Choose inverter of greater power level 2、 Reduce the load and check the motor and mechanical condition

Fault name	Motor overload
------------	----------------

Section VI. Fault Diagnosis & Solutions

Panel display	Fault No.11= Err11
Fault investigation	<ol style="list-style-type: none"> 1、 Small type selection of inverter 2、 Improper setup of P9.01 3、 Overload or motor stall
Fault countermeasures	<ol style="list-style-type: none"> 1、 Choose inverter of greater power level 2、 Set P9.01 correctly 3、 Reduce the load and check the motor and mechanical condition

Fault name	Input phase lack
Panel display	Fault No.12= Err12
Fault investigation	<ol style="list-style-type: none"> 1、 Drive board anomalies 2、 Lightning protection board (BESP) anomalies 3、 Control board anomalies 4、 3-phase input power-supply anomalies
Fault countermeasures	<ol style="list-style-type: none"> 1、 Replace driver, power- supply board or contactor 2、 For technical support 3、 Eliminate external loop faults

Fault name	Output phase lack
Panel display	Fault No.13= Err13
Fault investigation	<ol style="list-style-type: none"> 1、 Wiring between motor and inverter anomalies 2、 Inverter unbalanced 3-phase output 3、 Drive board anomalies 4、 Module anomalies
Fault countermeasures	<ol style="list-style-type: none"> 1、 Eliminate external loop faults 2、 Check 3-phase winding and eliminate faults

Section VI. Fault Diagnosis & Solutions

	3、 For technical support
--	--------------------------

Fault name	Module overheating
Panel display	Fault No.14= Err14
Fault investigation	<ol style="list-style-type: none"> 1、 Air duct block 2、 Fan damage 3、 High ambient temperature 4、 Module thermistor damage 5、 Inverter module damage
Fault countermeasures	<ol style="list-style-type: none"> 1、 Clean air dust 2、 Replace the fan 3、 Reduce ambient temperature 4、 Replace thermistor 5、 Replace inverter module

Fault name	External equipment fault
Panel display	Fault No.15= Err15
Fault investigation	<ol style="list-style-type: none"> 1、 Input external fault signal through DI 2、 Input external fault signal through IO
Fault countermeasures	<ol style="list-style-type: none"> 1、 Reset operation

Fault name	Communication fault
Panel display	Fault No.16= Err16
Fault investigation	<ol style="list-style-type: none"> 1、 Abnormal communication cable 2、 Wrongly set communication expansion card P0.28

Section VI. Fault Diagnosis & Solutions

	<ul style="list-style-type: none"> 3、Wrongly set communication parameter PD group 4、 Position machine operation anomalies
Fault countermeasures	<ul style="list-style-type: none"> 1、 Check the communication cable 2、 Set communication expansion card type correctly 3、 Set communication parameter correctly 4、 Check position machine cable

Fault name	Contactor fault
Panel display	Fault No.17= Err17
Fault investigation	<ul style="list-style-type: none"> 1、 Input phase lack 2、 Drive board , contactor anomalies
Fault countermeasures	<ul style="list-style-type: none"> 1、 Eliminate external loop faults 2、 Replace driver, power- supply board or contactor

Fault name	Current inspection fault
Panel display	Fault No.18= Err18
Fault investigation	<ul style="list-style-type: none"> 1、 Drive board anomalies 2、 Hall devices anomalies
Fault countermeasures	<ul style="list-style-type: none"> 1、 Replace drive board 2、 Replace hall devices

Fault name	Motor tuning fault
Panel display	Fault No.19= Err19
Fault investigation	<ul style="list-style-type: none"> 1、 Parameter identification process overtime 2、 Wrongly set motor parameters
Fault	<ul style="list-style-type: none"> 1、 Check wire between inverter and motor

Section VI. Fault Diagnosis & Solutions

countermeasures	2、 Set motor parameters correctly according to the nameplate
-----------------	--

Fault name	Encoder /PG card fault
Panel display	Fault No.20= Err20
Fault investigation	<ol style="list-style-type: none"> 1、 Encoder anomalies 2、 PG card anomalies 3、 Encoder type mismatch 4、 Encoder connections fault
Fault countermeasures	<ol style="list-style-type: none"> 1、 Replace encoder 2、 Replace PG card 3、 Set motor encoder type correctly 4、 Eliminate circuit faults

Fault name	EEPROM read & write fault
Panel display	Fault No.21= Err21
Fault investigation	1、 EEPROM chip damage
Fault countermeasures	1、 Replace main control board

Fault name	Inverter hardware fault
Panel display	Fault No.22= Err22
Fault investigation	<ol style="list-style-type: none"> 1、 Presence of overvoltage 2、 Presence of overcurrent
Fault countermeasures	<ol style="list-style-type: none"> 1、 Treat according to overvoltage fault 2、 Treat according to overcurrent fault

Section VI. Fault Diagnosis & Solutions

Fault name	Short circuit to ground fault
Panel display	Fault No.23= Err23
Fault investigation	1、 Motor short circuit to ground
Fault countermeasures	1、 Replace cable or motor

Fault name	Total running time arrival fault
Panel display	Fault No.26= Err26
Fault investigation	1、 Total running time arrive the set value
Fault countermeasures	1、 Clear record information using parameter initialization function

Fault name	User-defined fault 1
Panel display	Fault No.27= Err27
Fault investigation	1、 Input user-defined fault 1 signal through multi-function terminal DI 2、 Input user-defined fault 1 signal through virtual IO function
Fault countermeasures	1、 Reset operation

Fault name	User-defined fault 2
Panel display	Fault No.28= Err28
Fault investigation	1、 Input user-defined fault 2 signal through multi-function terminal DI 2、 Input user-defined fault 2 signal through virtual IO function
Fault countermeasures	1、 Reset operation

Fault name	Total power-on time arrival fault
------------	-----------------------------------

Section VI. Fault Diagnosis & Solutions

Panel display	Fault No.29= Err29
Fault investigation	1、 Total power-on time arrive the set value
Fault countermeasures	1、 Clear record information using parameter initialization function

Fault name	Load off fault
Panel display	Fault No.30= Err30
Fault investigation	1、 Inverter running current less than P9.64
Fault countermeasures	1、 Confirm whether load off or P9.64, P9.65parameter settings is in accordance with the actual operating condition

Fault name	PID feedback loss during operation fault
Panel display	Fault No.31= Err31
Fault investigation	1、 PID feedback less than PA.26 set value
Fault countermeasures	1、 Check PID feedback signal or set PA.26 to a proper value

Fault name	Each wave current limiting fault
Panel display	Fault No.40= Err40
Fault investigation	1、 Excessive load or motor stall 2、 Small type selection of inverter.
Fault countermeasures	1、 Reduce the load and check the motor and mechanical condition 2、 Choose inverter of greater power level

Fault name	Motor switching fault
Panel display	Fault No.41= Err41
Fault investigation	1、 Change current motor selection during inverter operation

Section VI. Fault Diagnosis & Solutions

Fault countermeasures	1、 Switch the motor after inverter stopped.
-----------------------	---

Fault name	Excessive speed deviation fault
Panel display	Fault No.42= Err42
Fault investigation	1、 Improper set inspection parameters P9.69、 P9.60 2、 Wrongly set encoder parameters 3、 No parameter identification
Fault countermeasures	1、 Set inspection parameters properly according to actual situation 2、 Set motor encoder parameters correctly 3、 Motor parameter identification

Fault name	Motor over speed fault
Panel display	Fault No.43= Err43
Fault investigation	1、 No parameter identification 2、 Wrongly set encoder parameters 3、 Improper set inspection parameters P9.69、 P9.60
Fault countermeasures	1、 Motor parameter identification 2、 Set motor encoder parameters correctly 3、 Set inspection parameters properly according to actual situation

Fault name	Motor overtemperature fault
Panel display	Fault No.45= Err45
Fault investigation	1、 Temperature sensor wiring loose 2、 Motor over temperature
Fault countermeasures	1、 Check sensor wiring and eliminate fault

	2、Reduced carrier frequency or take other cooling measures for the motor
--	--

Fault name	Initial position fault
Panel display	Fault No.51= Err51
Fault investigation	1、Excessive deviation between motor parameters and the practical value
Fault countermeasures	1、Reconfirm motor parameter settings, pay attention to the rated current value

6-2 Common fault and solutions

During the inverter using process, the following faults may occur. Please conduct simple fault analysis by referring to the methods below:

No.	Fault Phenomenon	Possible Cause	Solution
1	No display or error codes occur upon power-on	Abnormal input power supply, switch power supply fault of driven board, rectifier bridge damage, inverter buffer resistance damage, control board/keyboard fault, control board/driven board/keyboard disconnection	Check input power supply, bus voltage, re-plug 26 core cable, consult the manufacturer
2	Display "510" upon power-on	Poor contact between driven board and control board, device damage on control board, motor or motor cable short circuited, hall fault, grid under voltage	Re-plug 26 core cable, consult the manufacturer
3	"Error 23=Err23" alarming upon power on	The motor or the output line is short circuited to the earth, the inverter is damaged.	Measure the insulation of the motor and output line with magneto-ohmmeter, consult the manufacturer.
4	The inverter displays normally upon power-on, but "510" is displayed upon running and stops immediately	The fan is either damaged or blocked, peripheral controller short circuited	Replace the fan, exclude external short-circuit fault
5	Frequent fault report ERR14=Err14 (module overheating)	The carrier frequency is set too high, the fan is damaged or the air duct is blocked, inverter internal components damaged	Replace the fan, clean air duct, reduce carrier frequency (P0.15), consult manufacturer.
6	Motor no rotating after inverter power-on	Motor or motor cable, wrongly set inverter parameters (motor parameter), poor contact	Replace the motor or remove the mechanical fault, check and reset the parameters, confirm connection between

		between driven board and control board, driven board fault	inverter and motor
7	DI terminal invalid	Wrongly set inverter parameters, wrong external signal, SP and +24V jumper loosening, control board fault	Check and reset the P4relevant parameters,reconnect cables, reconfirm PLC and +24V jumper, consult the manufacturer.
8	Closed loop vector control, motor speed cannot ascend	Encoder fault; PG card fault; drive board fault; encoder wrong connection or poor contact	Replace encoder&reconfirm connections; replace PG card; consult manufacturer.
9	The inverter frequently reports over current fault & over voltage fault	Motor wrongly set parameters,improper acc./dec. time, load fluctuation	Reset motor parameters or motor tuning, set proper acc./dec.time,consult manufacturer.

Caution:

- ※ After power off and within 5 minutes of charging indicator light(! CHARGE)out , please not touch any spare parts inside the machine. The operator must use instrument to confirm capacitor discharge is completed, then could implement machine operation, or there may be electric shock risk!
- ※ Please do not touch the printed circuit board and IGBT etc internal device without electrostatic prevention measures. Or it could lead to the damage of components

Section VII. Inspection & Maintenance

7-1 Inspection and Maintenance

Under normal working conditions, in addition to daily inspection, the frequency converter should be subject to regular inspection (for example inspection for overhaul or as specified but at an interval of at most six months). Please refer to the following table in order to prevent faults.

Daily	Regular	Check item	Check details	Method	Criterion
√		LED display	If any abnormal display	Visual check	As per use state
√	√	Fan	If any abnormal noise or vibration	Visual and audible check	No anomalies
√		Surrounding conditions	Temperature, humidity, dust content, harmful gas, etc.	Visual/audible/sensory check	As per 2-1 item
√		Input output voltage	If any abnormal input, output voltage	Measure R, S, T and U, V, W terminals	As per standard specifications
	√	Main circuit	Fasteners whether loose, if any signs showing overheat, discharging, or too high dust content, or the air piping is blocked	Check visually, tighten the fastenings, and clean the related parts	No anomalies
	√	Electrolytic capacitor	If any abnormal appearance	Check visually	No anomalies
	√	Current-conducting leads or blocks	Loose or not	Check visually	No anomalies
	√	Terminals	If the screws or bolts loose	Tighten the loose screws or bolts	No anomalies

“√” means need daily check or regularly check.

For inspection, DO not disassemble or shake the parts without reason, or pull off the plug-in parts at Random. Otherwise, the unit will not operate normally, or can not enter the mode of fault display, or causes faults of components or even parts of the main switch components IGBT module is damaged.

When needing measurement, the user should note that much different results will be gained possibly if the measuring is performed with different instruments. It is recommended that the input voltage be measured with pointer-type voltmeter, output voltage with rectification voltmeter, input and output current with tong-test ammeter, and power with electrically-driven wattmeter.

7-2 Regular replacement of the device

In order to ensure the operation reliability of the frequency converter, in addition to regular maintenance and inspection, all the parts suffering long-term mechanical wear should be replaced at a regular interval, which includes all cooling fans and the filtering capacitors of main circuits for energy buffer and interchange and PCBs. For continuous use under normal conditions, these parts can be replaced according to the following table and the operating environment, loads and the current state of frequency converter.

Part name	Standard replacement years
Cooling fan	1~3 years
Filtering capacitor	4~5 years
PCB (printed circuit board)	5~8 years

7-3 Storage

The following actions must be taken if the frequency converter is not put into use immediately after delivery to the user and need to keep well for the time being or stored for a long time:

- ※ Stored in a dry and adequately-ventilated place without dust and metal powder at the temperature specified in the specifications.
- ※ If the frequency converter is not put into use after one year, a charge test should be made, so as to resume the performance of the filtering capacitor of main circuit in it. For charging, a voltage regulator should be used to slowly increase the input voltage of the frequency converter until it reaches the rating, and the charge should last more than 1~2 hours. This test should be made at least once a year.
- ※ Don't perform breakdown test at Random, for this test will cause shorter life of the frequency converter. The insulation test must be performed after the insulation resistance is measured with a 500-volt mega ohm and this value must not be less than 4MΩ.

7-4 Measuring and Judgment

- ※ If the current is measured with the general instrument, imbalance will exists for the current at the input terminal. Generally, differing by not more than 10% is normal. If it differs by 30%, inform the factory to replace the rectification bridge, or check if the error of three-phase input voltage is above 5V.

- ※ If the three-phase output voltage is measured with a general multi-meter, the read data is not accurate due to the interference of carrier frequency and only for reference.

7-5 Safety Precaution

- ※ Only specially trained persons are allowed to disassemble,replace the drive components.
- ※ Before the inspection and maintenance,inverter must be confirmed at least 5 minutes after power off or charged (CHARGE) light is off,otherwise there is risk of electric shock.
- ※ Avoid metal parts leaving in the drive, or it may result in equipment damage.



Appendix I RS485 Communication Protocol

I-1 RS485 communication

DSI-400 series inverter as internal RS485 communication circuit. It contains the following resources:

Table 2 Jumper description

Jumper number	Description
J1	RS485 Termination resistor selection

I-2 Communication protocol

I-2-1 Protocol content

The serial communication protocol defines the information content and format of the use of the transmission in serial communication. Including: the host polling (or broadcast) format, host encoding methods. Content including: require action of the function code, data transmission and error checking and so on. Slave machine's response is the same structure, including: action confirmation, return data and error checking. Slave error occurred when receiving information, or can not do what the host request action, it will organize a fault messages the response back to the host computer.

Application mode:

The inverter accessing with "single main multi-slave" PC/PLC control network which equipped with RS485 bus.

Bus structure:

(1) Interface mode

RS485 hardware interface

(2) Transmission mode

Asynchronous serial, half-duplex transmission. At the same time host and slave computer can only permit one to send data while the other can only receive data. Data in the process of serial asynchronous communication is in the message format and sent one frame by one frame.

(3) Topological mode

In single-master system, the setup range of slave address is 1 to 247. Zero refers to

broadcast communication address. The address of slave must be exclusive in the network. That is one condition of one slave machine.

I-3 Protocol Description

DSI-400 series inverter communication protocol is an asynchronous serial master-slave Modbus communication protocol, only one device in the network (master) to establish protocol (known as the "query / command"). Other device (slave) can only provide data response to the host query / command, or make the appropriate action according to the host query / command. Host refers to a personal computer (PC), industrial control equipment, or programmable logic controller (PLC), etc. The slave indicates DSI-400 inverter. Host can not only communicate separately with the slave, but also broadcast messages to the lower machine. For separate access to the host query / command, the slave should return a message (called the response), and for broadcast information issued by host machine, feedback needs not to be responded to the host.

Communication data structure DSI-400 series inverter Modbus protocol communication data format is as follows: using RTU mode, messages are sent at least at interval of 3.5 bytes times pause. In a variety of bytes in the network baud rate of time, this could be most easily achieved (see below T1-T2-T3-T4 shown). The transmission of a do main is the device address.

Transmission characters are hexadecimal 0..9, A..F. Network equipment continues to detect the network bus, including a pause interval of time. When the first field (the address field) is received, each device decodes it to determine whether sent to their own. At least 3.5 bytes times pause after the last transmitted character, a calibration of the end of the message. A new message may start after this pause.

The entire message frame must be used as a continuous stream. If the pause time frame prior to the completion of more than 1.5 byte times, the receiving device will refresh the incomplete message and assumes that the next byte will be the address field of a new message. Similarly, if a new message starts in less than 3.5 bytes times following the previous message, the receiving device will consider it a continuation of the previous message. This will set an error, as the value in the final CRC field will not be valid for the combined messages. A typical message frame is shown below.

RTU frame format:

START	3.5-character time
Slave address ADDR	Communication address: 1~247
Command code CMD	03: Read slave parameters; 06: Write slave parameters
DATA(N-1)	Function code parameter address, function code parameter number, function code parameter value, etc.
DATA(N-2)	
.....	

DATA0	
CRC CHK low order	Detection value: CRC value.
CRC CHK high order	
END	At least 3.5-character time

CMD(command instructions) and DATA(material words description)

Command code: 03H, reads N words(There are 12 characters can be read at most). For example: the inverter start address F0.02 of the slave machine address 01 continuously reads two consecutive values.

Host command

ADR	01H
CMD	03H
Start address high order	F0H
Start address low order	02H
Register number high order	00H
Register number low order	02H
CRC CHK low order	CRC CHK values to be calculated
CRC CHK high order	

Slave response

PD.05=0:

ADR	01H
CMD	03H
Byte number high order	00H
Byte number low order	04H
Data P002H high order	00H
Data P002H low order	00H

Data P003H high order	01H
<i>CRC CHK low order</i>	CRC CHK values to be calculated
<i>CRC CHK high order</i>	

PD.05=1:

ADR	01H
CMD	03H
Byte number	04H
Data F002H high order	00H
Data F002H low order	00H
Data F003H high order	00H
Data F003H low order	01H
<i>CRC CHK low order</i>	CRC CHK values to be calculated
<i>CRC CHK high order</i>	

Command code: 06H write a word

For example: Write 5000(1388H) into F00AH which slave address is 02H.

Master command information

ADR	02H
CMD	06H
Data address high order	F0H
Data address low order	0AH
Data content high order	13H
Data content low order	88H
<i>CRC CHK low order</i>	CRC CHK values to be calculated
<i>CRC CHK high order</i>	

Slave response

ADR	02H
CMD	06H
Data address high order	F0H
Data address low order	0AH
Data content high order	13H
Data content low order	88H
<i>CRC CHK low order</i>	CRC CHK values to be calculated
<i>CRC CHK high order</i>	

I-4 Cyclical Redundancy Check:

Cyclical Redundancy Check—CRC mode: CRC(Cyclical Redundancy Check) is in RTU frame format, message contains an error-checking field that is based on a CRC method. The CRC field checks the contents of the entire message. The CRC field is two bytes, containing a 16-bit binary value. The CRC value is calculated by the transmitting device, which appends the CRC to the message. The receiving device recalculates a CRC during receipt of the message, and compares the calculated value to the actual value it received in the CRC field. If the two values are not equal, an error results. The CRC is started by 0xFFFF. Then a process begins of applying successive 8-bit bytes of the message to the current contents of the register. Only the eight bits of data in each character are used for generating the CRC. Start and stop bits, and the parity bit, DO not apply to the CRC.

During generation of the CRC, each eight-bit character is exclusive XOR with the register contents. Then the result is shifted in the direction of the least significant bit (LSB), with a ZERO filled into the most significant bit (MSB) position. The LSB extracted and examined. If the LSB was 1, the register then exclusive XOR with a preset, fixed value. If the LSB was 0, no exclusive XOR takes place. This process is repeated until 8 shifts have been performed. After the last (8) shift, the next eight-bit byte is exclusive XOR with the register's current value, and the process repeats for 8 more shifts as described above. The final contents of the register, after all the bytes of the message have been applied, is the CRC value.

When CRC appended to the message, the low byte is appended first, and then the high byte.

CRC calculation program:

```
unsigned int cal_crc16 (unsigned char *data, unsigned int length)
{
    unsigned int i,crc_result=0xffff;
    while(length--)
    {
        crc_result^=*data++;
        for(i=0;i<8;i++)
        {
            if(crc_result&0x01)
                crc_result=(crc_result>>1)^0xa001;
            else
```

```
crc_result=crc_result>>1;
}
}
crc_result=((crc_result&0xff)<<8)|(crc_result>>8);
return(crc_result);
```



I-5 Communication parameter address

The chapter is about communication contents, it's used to control the inverter operation, the status of the inverter and related parameter setup. Read and write function code parameters (Some function codes are not able to be changed, only for the manufacturer use.). The mark rules of function code parameters address:

The group number and mark of function codes are parameter address for indication rules.

High byte: F0~FF(P group), A0~AF(A group), 70~F(U group)Low byte: 00~FF

For example: P3.12, the address indicates F30C

Caution:

Group PF: Parameters could not be read or be modified.

Group U: Parameters could be read but not be modified.

Some parameters can not be changed during operation, some parameters regardless of the kind of state the inverter in, the parameters can not be changed. Change the function code parameters, pay attention to the scope of the parameters, units, and relative instructions.

Besides, if EEPROM is frequently stored, it will reduce the service life of EEPROM. In some communication mode, function code needn't to be stored as long as changing the RAM value.

Group P: to achieve this function, change high order F of the function code address into 0.

Group A: to achieve this function, change high order A of the function code address to be 4.

Corresponding function code address are indicated below:

High byte: 00~0F(P group), 40~4F(A group)Low byte: 00~FF

For example:

Function code P3.12 can not be stored into EEPROM, address indicates to be 030C,function code A0-05 can not be stored in EEPROM, address indicates to be 4005; This address can only act writing RAM, it can not act reading, when act reading, it is invalid address. For all parameters, command code 07H can be used to achieve this function.

Stop/running parameter:

Parameter addr.	Parameter description
1000	* Communication setup value(-10000~10000)(Decimal)
1001	Running frequency
1002	Bus voltage

1003	Output voltage
1004	Output current
1005	Output power
1006	Output torque
1007	Running speed
1008	DI input status
1009	DO output status
100A	A1 voltage
100B	A2 voltage
100C	A3 voltage
100D	Counting value input
100E	Length value input
100F	Load speed
1010	PID setup
1011	PID feedback
1012	PLC process
1013	PULSE input pulse frequency, unit 0.01kHz
1014	Feedback speed, unit 0.1Hz
1015	Rest running time
1016	A1 voltage before correction
1017	A2 voltage before correction
1018	A3 voltage before correction
1019	Line speed
101A	Current power on time
101B	Current running time
101C	PULSE input pulse frequency, unit 1Hz
101D	Communication setup value
101E	Actual feedback speed
101F	Main frequency X display
1020	Auxiliary frequency Y display

Caution:

The communication setup value is percentage of the relative value, 10000 corresponds to 100.00% , -10000 corresponds to -100.00%.For data of dimensional frequency,the percentage value is the percentage of the maximum frequency.For data of dimensional torque, the percentage is P2.10, A2.48, A3.48, A4.48 (Torque upper digital setup, corresponding to

the first, second, third, fourth motor).

Control command input to the inverter (write-only)

Command word address	Command function
2000	0001: Forward operation
	0002: Reserved operation
	0003: Forward jog
	0004: Reserved jog
	0005: Free stop
	0006: Speed-Down stop
	0007: Fault reset

Read inverter status: (read-only)

Status word address	Status word function
3000	0001: Forward operation
	0002: Reserved operation
	0003: Stop

Parameters lock password check: (if the return is the 8888H, it indicates the password checksum pass)

Password address	Contents of input password
1F00	*****

Digital output terminal control: (write-only)

Command address	Command content
2001	BIT0: DO1 Output control
	BIT1: DO2 Output control
	BIT2 RELAY1 Output control
	BIT3: RELAY2 Output control
	BIT4: FMR Output control
	BIT5: VY1
	BIT6: VY2
	BIT7: VY3
	BIT8: VY4

	BIT9: VY5
--	-----------

Analog output AO1 control: (write-only)

Command address	Command content
2002	0~7FFF indicates 0%~100%

Analog output AO2control: (write-only)

Command address	Command content
2003	0~7FFFIndicates 0%~100%

(PULSE)output control : (write-only)

Command address	Command content
2004	0~7FFFIndicates 0%~100%

Inverter fault description:

Inverter fault address	Inverter fault information
8000	0000: No fault 0001: Reserved 0002: Speed-up over current 0003: Speed-down over current 0004: Constant speed over current 0005: Speed-up over voltage 0006: Speed-DOWN over voltage 0007: Constant speed over voltage 0008: Buffer resistance overload fault 0009: Under-voltage fault 000A: Inverter overload 000B: Motor overload 000C: Input phase lost 000D: Output phase lost 000E: Module overheating

000F: External fault
0010: Communication fault
0011: Contactor fault
0012: Current detection fault
0013: Motor tuning fault
0014: Encoder/PG card fault
0015: Parameter read and write fault
0016: Inverter hardware fault
0017: Motor earthing short-circuit fault
0018: Reserved
0019: Reserved
001A: Running time arrive fault
001B: User defined fault 1
001C: User defined fault 2
001D: Power on time arrive fault
001E: Load off
001F: PID feedback lost during operation
0028: Fast current limit timeout fault
0029: Motor shifting fault during operation
002A: Excessive speed deviation
002B: Motor over speed
002D: Motor over-temperature
005A: Encoder line number setup fault
005B: Encoder not connected
005C: Initial position error
005E: Speed feedback fault

Communication fault information describing data (fault code):

Communication fault address	Fault function description
8001	0000: No fault 0001: Password error

	0002: Command code error	0003: CRC check error
	0004: Invalid address	0005: Invalid parameter
	0006: Parameter change invalid	0007: The system is locked
	0008: Operating EEPROM	

Pd group communication parameters description

Pd.00	Baud rate	Factory default value	6005
	Setup range	1 bit: MODBUS baud rate 0: 300BPS 1: 600BPS 2: 1200BPS 3: 2400BPS 4: 4800BPS 5: 9600BPS 6: 19200BPS 7: 38400BPS 8: 57600BPS 9: 115200BPS	

This parameter is used to set the data transfer rate between the host computer and the inverter. Caution : The baud rate of the position machine and the inverter must be consistent.

Or, communication is impossible. The higher the baud rate is, the faster the communication is.

Pd.01	Data format	Factory default value	0
	Setup range	0: No check: data format <8,N,2> 1: Even parity check: data format <8,E,1> 2: Odd parity check: data format <8,O,1> 3: No check: data format <8-N-1>	

The data format of the position machine and the inverter setup must be consistent, otherwise communication is impossible.

Pd.02	Local address	Factory default value	1
	Setup range	1~247, 0 is broadcast address.	

When the local address is set to 0, that is the broadcast address, achieve position machine's broadcast function. The local address is unique (except for the broadcast address), which is the basis for the position machine and the inverter point to point communication.

Pd.03	Response delay	Factory default value	2ms
	Setup range	0~20ms	

Response delay: It refers to the interval time from the inverter finishes receiving data to

sending data to the position machine. If the response delay is less than the system processing time, then the response based on the time delay of the system processing time. If the response delay is more than the system processing time, after the system process the data, it should be delayed to wait until the response delay time is up, then sending data to host machine.

Pd.04	Communication Overtime	Factory default value	0.0 s
	Setup range	0.0 s (Invalid) 0.1~60.0s	

When the function set to 0.0s, the communication overtime parameter is invalid.

When the function code is set to valid value, if the interval time between one communication with the next communication exceeded the communications overtime, the system will report communication fault error (fault serial 16= E.CoF1) . Under normal circumstances, it will be set to invalid value. If the system of continuous communication, setting parameters, you can monitor the communication status.

Pd.05	Communication protocol selection	Factory default value	0
	Setup range	0: Non standard Modbus protocol 1: Standard Modbus protocol	

Pd.05=1: Select Standard Modbus protocol.

Pd.05=0: Reading command, the slave returns the number of bytes which has one more byte than the standard Modbus protocol, for specific please refer to the protocol, the part of the "5 communication data structure".

Pd.06	Communication read the current resolution	Factory default value	0
	Setup range	0: 0.01A 1: 0.1A	

To determine when the communication reads the output current, what the output current value unit is.

Appendix II Parameter Settings List

Parameters factory default values are shown as below:

Code	Description/Display	Factory setting	Set value 1	Set value 2	Page
U0	Monitor function group: U0.00-U0.61				40
U0.00	Running frequency	0.01Hz			40
U0.01	Set frequency	0.01Hz			40
U0.02	DC bus voltage	0.1V			40
U0.03	The output voltage	1V			40
U0.04	Motor output current	0.01A			40
U0.05	The output power	0.1kW			41
U0.06	Output torque	0.1%			41
U0.07	DI input status	1			41
U0.08	Y output status	1			41
U0.09	AI1 voltage	0.01V			41
U0.10	AI2 voltage	0.01V			41
U0.11	AI3 voltage	0.01V			41
U0.12	Count value	1			42
U0.13	Length value	1			42
U0.14	Load speed display	1			42
U0.15	PID set point	1			42
U0.16	PID feedback	1			42
U0.17	PLC stage	1			42
U0.18	PULSE pulse input frequency	0.01kHz			42
U0.19	Speed feedback	0.1Hz			42

Appendix II Parameter Settings List

U0.20	Surplus running time	0.1Min			42
U0.21	AI1 voltage before correction	0.001V			42
U0.22	AI2 voltage before correction	0.001V			42
U0.23	AI3 voltage before correction	0.001V			42
U0.24	Linear velocity	1m/Min			42
U0.25	Current power on time	1Min			42
U0.26	Current running time	0.1Min			42
U0.27	PULSE pulse input frequency	1Hz			42
U0.28	Communication set value	0.01%			42
U0.29	Encoder feedback speed	0.01Hz			43
U0.30	Main frequency X display	0.01Hz			43
U0.31	Auxiliary frequency Y display	0.01Hz			43
U0.32	View arbitrary memory address	1			43
U0.33	Synchronous motor rotor position	0.0°			43
U0.34	Motor temperature	1℃			43
U0.35	Target torque	0.1%			43
U0.36	Rotary variable position	1			43
U0.37	Power factor angle	0.1			43
U0.38	ABZ position	0.0			43
U0.39	VF target voltage separation	1V			43
U0.40	VF output voltage separation	1V			43
U0.41	DI input status intuitive display	-			43
U0.42	DO output status intuitive display	-			44
U0.43	DI function status intuitive display1	1			44
U0.44	DI function status intuitive display2	1			44

Appendix II Parameter Settings List

U0.45	Fault information	0			44
U0.46	Reserved	-			44
U0.47	Reserved	-			44
U0.48	Reserved	-			44
U0.58	Z signal counter	-			44
U0.59	Set frequency	0.01%			44
U0.60	Running frequency	0.01%			44
U0.61	Inverter status	1			44
U0.62	Current fault code	1			44
U0.63	Point to point communication	0.01%			44
U0.64	number of Slave	1			44
U0.65	Torque limit	0.01%			44
P0	Basic function group: P0.00-P0.28				45
P0.00	GP type display	-			45
P0.01	Motor 1 control mode	0			45
P0.02	Command source selection	0			45
P0.03	Main frequency source X selection	4			46
P0.04	Auxiliary frequency source Y selection	0			47
P0.05	Auxiliary frequency source Y range selection	0			48
P0.06	Auxiliary frequency source Y range	100%			48
P0.07	Frequency source stacking selection	00			48
P0.08	Preset frequency	50.00Hz			49
P0.09	Running direction	0			49
P0.10	Maximum frequency	50.00Hz			49
P0.11	Frequency source upper limit	0			49

Appendix II Parameter Settings List

P0.12	Frequency upper limit	50.00Hz			49
P0.13	Frequency upper limit offset	0.00Hz			49
P0.14	Frequency lower limit	0.00Hz			50
P0.15	Carrier frequency	-			50
P0.16	Carrier frequency adjusting with temperature	0			50
P0.17	Acceleration time 1	-			50
P0.18	Deceleration time 1	-			50
P0.19	Acc./ dec. time unit	1			51
P0.21	Auxiliary frequency source offset frequency	0.00Hz			51
P0.22	Frequency command resolution	2			51
P0.23	Digital setup frequency memory selection upon stop	0			51
P0.24	Motor selection	0			52
P0.25	Acceleration / deceleration reference frequency	0			52
P0.26	Frequency UP/DOWN reference upon running	0			52
P0.27	Command source& frequency source binding	000			52
P0.28	Communication expansion card	0			53
P1	Parameters for motor 1: P1.00-P0.37				54
P1.00	Motor type selection	0			54
P1.01	Rated power	-			54
P1.02	Rated voltage	-			54
P1.03	Rated current	-			54
P1.04	Rated frequency	-			54
P1.05	Rated revolving speed	-			54
P1.06	Asynchronous motor stator resistance	-			54
P1.07	Asynchronous motor rotor resistance	-			54

Appendix II Parameter Settings List

P1.08	Asynchronous motor leakage inductance	-			54
P1.09	Asynchronous motor mutual inductance	-			54
P1.10	Asynchronous motor no load current	-			54
P1.27	Encoder pulses number	2500			55
P1.28	Encoder type	0			55
P1.30	ABZ incremental encoder AB phase	0			55
P1.34	Rotary transformer pole pairs	1			55
P1.36	PG dropped inspection time	0.0s			56
P1.37	Tuning selection	0			56
P2	Vector control function group: P2.00-P2.22				57
P2.00	Speed loop proportional gain 1	30			57
P2.01	Speed loop integration time1	0.50s			57
P2.02	Switching frequency1	5.00Hz			57
P2.03	Speed loop proportional gain 2	20			57
P2.04	Speed loop integration time 2	1.00s			57
P2.05	Switching frequency 2	10.00Hz			57
P2.06	Vector control slip gain	100%			57
P2.07	Speed-loop filter time	28			58
P2.08	Vector control over-excitation gain	64			58
P2.09	Torque upper limit source in speed control mode	0			58
P2.10	Torque upper limit digital setup in speed control mode	150.0%			58
P2.13	Excitation regulation proportional gain	2000			58
P2.14	Excitation regulation integration gain	1300			58
P2.15	Torque regulation proportional gain	2000			58
P2.16	Torque regulation integration gain	1300			58

Appendix II Parameter Settings List

P2.17	Speed loop integration attribute	0			59
P2.21	Max torque coefficient of field weakening area	100%			59
P2.22	Regenerative power limit selection	0%			59
P2.23	Regenerative power limit				59
P3	V/F control group: P3.00-P3.15				59
P3.00	V/F curve setup	0			59
P3.01	Torque boost value	-			60
P3.02	Torque boost cut-off frequency	50.00Hz			60
P3.03	Multi-point V/F frequency point F1	0.00Hz			61
P3.04	Multi-point V/F voltage point V1	0.0%			61
P3.05	Multi-point V/F frequency point F2	0.00Hz			61
P3.06	Multi-point V/F voltage point V2	0.0%			61
P3.07	Multi-point V/F frequency point F3	0.00Hz			61
P3.08	Multi-point V/F voltage point V3	0.0%			61
P3.09	V/F slip compensation gain	0.0%			61
P3.10	VF over-excitation gain	64			62
P3.11	VF oscillation suppression gain	-			62
P3.13	VF separation voltage source	0			62
P3.14	VF separation voltage digital setup	0V			62
P3.15	VF separation voltage rise time	0.0s			63
P3.16	VF separation voltage decline time	0.0s			63
P3.17	Stop mode selection for VF separation voltage	0			63
P3.18	Current limit level	150			63
P3.19	Current limit selection	1			63
P3.20	Current limit gain	20			63

Appendix II Parameter Settings List

P3.21	Compensation factor of Speed multiplying current limit	50			63
P3.22	voltage limit	770.0			63
P3.23	voltage limit selection	1			63
P3.24	Frequency gain for voltage limit	30			63
P3.25	voltage gain for voltage limit	30			63
P3.26	Frequency rise threshold during voltage limit	5			63
P4	Input Terminal: P4.00-P4.39				63
P4.00	DI1 terminal function selection	1			64
P4.01	DI2 terminal function selection	4			64
P4.02	DI3 terminal function selection	9			64
P4.03	DI4 terminal function selection	12			64
P4.04	DI5 terminal function selection	0			64
P4.05	DI6 terminal function selection	0			64
P4.06	DI7 terminal function selection	0			64
P4.07	DI8 terminal function selection	0			64
P4.08	DI9 terminal function selection	0			64
P4.09	DI10 terminal function selection	0			64
P4.10	DI filter time	0.010s			67
P4.11	Terminal command mode	0			67
P4.12	Terminal UP/DN variation rate	1.00Hz/s			70
P4.13	AI curve 1 minimum input	0.00V			70
P4.14	AI curve 1 minimum input corresponding setup	0.0%			70
P4.15	AI curve 1 maximum input	10.00V			70
P4.16	AI curve 1 maximum input corresponding setup	100.0%			70
P4.17	AI1 filter time	0.10s			70

Appendix II Parameter Settings List

P4.18	AI curve 2 minimum input	0.00V			71
P4.19	AI curve 2 minimum input corresponding setup	0.0%			71
P4.20	AI curve 2 maximum input	10.00V			71
P4.21	AI curve 2 maximum input corresponding setup	100.0%			71
P4.22	AI2 filter time	0.10s			71
P4.23	AI curve 3 minimum input	0.10V			71
P4.24	AI curve 3 minimum input corresponding setup	0.0%			71
P4.25	AI curve3 maximum input	4.00V			72
P4.26	AI curve 3 maximum input corresponding setup	100.0%			72
P4.27	AI3filter time	0.10s			72
P4.28	PULSE minimum input	0.00kHz			72
P4.29	PULSE minimum input corresponding setup	0.0%			72
P4.30	PULSE maximum input	50.00			72
P4.31	PULSE maximum input corresponding setup	100.0%			72
P4.32	PULSE filter time	0.10s			72
P4.33	AI curve selection	321			72
P4.34	AI below minimum input setup selection	000			73
P4.35	DI1 delay time	0.0s			73
P4.36	DI2 delay time	0.0s			73
P4.37	DI3 delay time	0.0s			73
P4.38	DI terminal effective mode selection 1	00000			73
P4.39	DI terminal effective mode selection 2	00000			74
P5	Output terminal: P5.00-P5.22				74
P5.00	Y1 terminal output mode selection	0			75
P5.01	FMR selection (open collector output terminal)	0			75

Appendix II Parameter Settings List

P5.02	Relay output selection(TA1.TB1.TC1)	2			75
P5.03	Expansion card relay output selection(TA2.TB2.TC2)	0			75
P5.04	DO1 output selection(open collector output terminal)	1			75
P5.05	Expansion cardDO2 output selection	4			75
P5.06	FMP output selection (pulse output terminal)	0			77
P5.07	AO1 output selection	0			77
P5.08	AO2 output selection	1			77
P5.09	FMP maximum output frequency	50.00kHz			78
P5.10	AO1 zero offset	0.0%			78
P5.11	AO1 gain	1.00			78
P5.12	AO2 zero offset	0.00%			78
P5.13	AO2 gain	1.00			78
P5.17	FMR output delay time	0.0s			78
P5.18	RELAY1 output delay time	0.0s			78
P5.19	RELAY2 output delay time	0.0s			78
P5.20	DO1 output delay time	0.0s			78
P5.21	DO2 output delay time	0.0s			78
P5.22	DO output terminal valid state selection	00000			78
P6	Start/stop control: P6.00-P6.15				79
P6.00	Start mode	0			79
P6.01	Revolving speed tracking mode	0			79
P6.02	Revolving speed tracking speed	20			80
P6.03	Start frequency	0.00Hz			80
P6.04	Start frequency holding time	0.0s			80
P6.05	Start dc braking current /pre-excitation current	0%			80

Appendix II Parameter Settings List

P6.06	Start dc braking time /pre-excitation time	0.0s			80
P6.07	Acceleration/deceleration mode	0			80
P6.08	S-curve initial-segment time proportion	30.0%			81
P6.09	S-curve end-segment time proportion	30.0%			81
P6.10	Stop mode	0			82
P6.11	DC braking initial frequency at stop	0.00Hz			82
P6.12	DC braking waiting time at stop	0.0s			82
P6.13	DC braking current at stop	0%			82
P6.14	DC braking time at stop	0.0s			82
P6.15	Brake utilization ratio	100%			83
P6.18	Catching a spinning motor current limit				83
P6.21	Demagnetization time for SVF				83
P6.23	Over excitation selection	0			83
P6.24	Over excitation suppression current gain	0			83
P6.25	Over excitation gain	1.25			
P7	Keyboard and display: P7.00-P7.14				83
P7.01	MF/REV key function selection	0			83
P7.02	STOP/RESET function	1			84
P7.03	LED running display parameter 1	1F			84
P7.04	LED running display parameter 2	0			84
P7.05	LED stop display parameter	0			84
P7.06	Load speed coefficient	1.0000			85
P7.07	Inverter module radiator temperature				85
P7.08	product ID				85
P7.09	Accumulative running time	0h			85

Appendix II Parameter Settings List

P7.10	Performance version number	-			85
P7.11	Software version No.	-			85
P7.12	Load speed display decimal digits	1			85
P7.13	Accumulative power-on time	-			85
P7.14	Accumulative power consumption	-			85
P8	Auxiliary Function: P8.00-P8.53				86
P8.00	Jog running frequency	2.00Hz			86
P8.01	Jog acceleration time	20.0s			86
P8.02	Jog deceleration time	20.0s			86
P8.03	Acceleration time 2	10.0s			86
P8.04	Deceleration time 2	10.0s			86
P8.05	Acceleration time 3	10.0s			86
P8.06	Deceleration time 3	10.0s			86
P8.07	Acceleration time 4	10.0s			86
P8.08	Deceleration time 4	10.0s			86
P8.09	Hopping frequency 1	0.00Hz			86
P8.10	Hopping frequency 2	0.00Hz			86
P8.11	Hopping frequency amplitude	0.00Hz			86
P8.12	Dead zone time of forward & Reserved rotations	0.0s			87
P8.13	Reserved rotation control	0			87
P8.14	Set frequency below lower limit running mode	0			87
P8.15	Droop control	0.00Hz			87
P8.16	Accumulative power-on time arrival setup	0h			87
P8.17	Accumulative running time arrival setup	0h			88
P8.18	Start protection selection	0			88

Appendix II Parameter Settings List

P8.19	Frequency detection value (FDT1)	50.00Hz			88
P8.20	Frequency detection hysteresis value (FDT1)	5.0%			88
P8.21	Frequency arrival detection amplitude	0.0%			89
P8.22	Acc./dec. hopping frequency validity	0			89
P8.25	Acc. time1 & acc. time 2 frequency switching point	0.00Hz			89
P8.26	Dec. time1 & dec. time 2 frequency switching point	0.00Hz			90
P8.27	Terminal jog priority	0			90
P8.28	Frequency detection value(FDT2)	50.00Hz			90
P8.29	Frequency detection hysteresis value(FDT2)	5.0%			90
P8.30	Random frequency arrival detection value1	50.00Hz			90
P8.31	Random frequency arrival detection range1	0.0%			90
P8.32	Random frequency arrival detection value2	50.00Hz			90
P8.33	Random frequency arrival detection range2	0.0%			90
P8.34	Zero-current detection level	5.0%			91
P8.35	Zero-current detection delay time	0.10s			91
P8.36	Output current over limit value	200.0%			92
P8.37	Output current over limit detection delay time	0.00s			92
P8.38	Random current arrival 1	100.0%			92
P8.39	Random current arrival range1	0.0%			92
P8.40	Random current arrival 2	100.0%			92
P8.41	Random current arrival range2	0.0%			92
P8.42	Timing function selection	0			93
P8.43	Running time timing selection	0			93
P8.44	Timing running time	0.0Min			93
P8.45	AI1 input voltage protection value lower limit	3.10V			93

Appendix II Parameter Settings List

P8.46	A11 input voltage protection value upper limit	6.80V			93
P8.47	Module temperature arrival	75℃			93
P8.48	Cooling fan control	0			93
P8.49	Wake-up frequency	0.00Hz			94
P8.50	Wake-up delay time	0.0s			94
P8.51	Sleep frequency	0.00Hz			94
P8.52	Sleep delay time	0.0s			94
P8.53	The running time arrival	0.0Min			94
P9	Overload and Protection : P9.00-P9.70				94
P9.00	Motor overload protection selection	1			94
P9.01	Motor overload protection gain	1.00			94
P9.02	Motor overload pre-alarm coefficient	80%			94
P9.03	Over-voltage stall gain	0			94
P9.04	Over-voltage stall protection voltage	130%			95
P9.07	Ground short circuit protection upon power-on	1			95
P9.09	Fault auto reset times	0			95
P9.10	Fault auto reset FAULT DO selection	0			95
P9.11	Fault auto reset interval	1.0s			95
P9.12	Input phase lack protection selection	11			95
P9.13	Output phase lack protection selection	1			96
P9.14	The first fault type	-			96
P9.15	The second fault type	-			96
P9.16	The latest fault type	-			96
P9.17	Third fault frequency	-			97
P9.18	Third fault current	-			97

Appendix II Parameter Settings List

P9.19	Third fault bus voltage	-		97
P9.20	Third fault input terminal	-		97
P9.21	Third fault output terminal	-		97
P9.22	Third fault inverter state	-		97
P9.23	Third fault power-on time	-		97
P9.24	Third fault running time	-		97
P9.27	Second fault frequency	-		97
P9.28	Second fault current	-		97
P9.29	Second fault bus voltage	-		97
P9.30	Second fault input terminal	-		97
P9.31	Second fault output terminal	-		98
P9.32	Second fault inverter state	-		98
P9.33	Second fault power-on time	-		98
P9.34	Second fault running time	-		98
P9.37	First fault frequency	-		98
P9.38	First fault current	-		98
P9.39	First fault bus voltage	-		98
P9.40	First fault input terminal	-		98
P9.41	First fault output terminal	-		98
P9.42	First fault inverter state	-		98
P9.43	First fault power-on time	-		98
P9.44	First fault running time	-		98
P9.47	Fault protection action selection 1	00000		98
P9.48	Fault protection action selection 2	00000		99
P9.49	Fault protection action selection 3	00000		99

Appendix II Parameter Settings List

P9.50	Fault protection action selection 4	00000			100
P9.54	Continued to run when fault frequency selection	0			100
P9.55	Abnormal backup frequency	100.0%			100
P9.56	Motor temperature sensor	0			100
P9.57	Motor overheating protection threshold	110℃			100
P9.58	Motor overheating pre-alarm threshold	90℃			100
P9.59	Transient stop selection	0			101
P9.60	Transient stop action pause protection voltage	90.0%			101
P9.61	Transient stop voltage recovery judgment time	0.50s			101
P9.62	Transient stop action judgment voltage	80.0%			101
P9.63	Load-off protection selection	0			102
P9.64	Load-off detection level	10.0%			102
P9.65	Load-off detection time	1.0s			102
P9.67	Over speed detection value	20.0%			102
P9.68	Over speed detection time	1.0s			102
P9.69	Excessive speed deviation detection value	20.0%			102
P9.70	Excessive speed deviation detection time	5.0s			102
PA	PID Function group: PA.00-PA.28				102
PA.00	PID reference source	0			103
PA.01	PID reference value	50.0%			103
PA.02	PID feedback source	0			103
PA.03	PID action direction	0			103
PA.04	PID reference feedback range	1000			104
PA.05	Proportional gain Kp1	20.0			104
PA.06	Integration time Ti1	2.00s			104

Appendix II Parameter Settings List

PA.07	Differential time Td1	0.000s			104
PA.08	PID cutoff frequency of Reserved rotation	2.00Hz			104
PA.09	PID deviation limit	0.0%			104
PA.10	PID differential amplitude limit	0.10%			104
PA.11	PID reference change duration	0.00s			104
PA.12	PID feedback filter time	0.00s			105
PA.13	PID output filter time	0.00s			105
PA.14	Reserved	-			105
PA.15	Proportional gain Kp2	20.0			105
PA.16	Integration time Ti2	2.00s			105
PA.17	Differential time Td2	0.000s			105
PA.18	PID parameter switching condition	0			105
PA.19	PID parameter switching deviation1	20.0%			105
PA.20	PID parameter switching deviation2	80.0%			105
PA.21	PID initial value	0.0%			106
PA.22	PID initial value retention time	0.00s			106
PA.23	Output deviation forward maximum value	1.00%			106
PA.24	Output deviation Reserved maximum value	1.00%			106
PA.25	PID integration attribute	00			106
PA.26	PID feedback loss detection value	0.0%			107
PA.27	PID feedback loss detection time	0s			107
PA.28	PID stop operation	0			107
Pb	Swing Frequency, Fixed Length and Counting: Pb.00-Pb.09				107
Pb.05	Setup length	1000m			108
Pb.06	Actual length	0m			108

Appendix II Parameter Settings List

Pb.07	Pulse number per meter	100.0			108
Pb.08	Counting value setup	1000			108
Pb.09	Designated counting value	1000			108
PC	MS Speed Function & Simple PLC Function : PC.00-PC.51				109
PC.00	MS command 0	0.0%			109
PC.01	MS command 1	0.0%			109
PC.02	MS command 2	0.0%			109
PC.03	MS command 3	0.0%			109
PC.04	MS command 4	0.0%			109
PC.05	MS command 5	0.0%			109
PC.06	MS command 6	0.0%			109
PC.07	MS command 7	0.0%			109
PC.08	MS command 8	0.0%			109
PC.09	MS command 9	0.0%			109
PC.10	MS command 10	0.0%			109
PC.11	MS command 11	0.0%			109
PC.12	MS command 12	0.0%			109
PC.13	MS command 13	0.0%			109
PC.14	MS command 14	0.0%			109
PC.15	MS command 15	0.0%			109
PC.16	PLC running mode	0			110
PC.17	PLC power off memory selection	00			111
PC.18	PLC 0segment running time	0.0s(h)			111
PC.19	PLC 0segment acc./dec. time	0			111
PC.20	PLC 1segment running time	0.0s(h)			111

Appendix II Parameter Settings List

PC.21	PLC 1segment acc./dec. time	0			111
PC.22	PLC 2 segment running time	0.0s(h)			111
PC.23	PLC 2 segment acc./dec. time	0			111
PC.24	PLC 3 segment running time	0.0s(h)			111
PC.25	PLC 3 segment acc./dec. time	0			111
PC.26	PLC 4 segment running time	0.0s(h)			111
PC.27	PLC 4 segment acc./dec. time	0			111
PC.28	PLC 5 segment running time	0.0s(h)			111
PC.29	PLC 5 segment acc./dec. time	0			111
PC.30	PLC 6 segment running time	0.0s(h)			111
PC.31	PLC 6 segment acc./dec. time	0			111
PC.32	PLC 7 segment running time	0.0s(h)			111
PC.33	PLC 7 segment acc./dec. time	0			111
PC.34	PLC 8 segment running time	0.0s(h)			111
PC.35	PLC 8 segment acc./dec. time	0			111
PC.36	PLC 9 segment running time	0.0s(h)			111
PC.37	PLC 9 segment acc./dec. time	0			111
PC.38	PLC 10 segment running time	0.0s(h)			111
PC.39	PLC 10 segment acc./dec. time	0			111
PC.40	PLC 11 segment running time	0.0s(h)			111
PC.41	PLC 11 segment acc./dec. time	0			111
PC.42	PLC 12 segment running time	0.0s(h)			112
PC.43	PLC 12 segment acc./dec. time	0			112
PC.44	PLC 13 segment running time	0.0s(h)			112
PC.45	PLC 13 segment acc./dec. time	0			112

Appendix II Parameter Settings List

PC.46	PLC 14 segment running time	0.0s(h)			112
PC.47	PLC 14 segment acc./dec. time	0			112
PC.48	PLC 15 segment running time	0.0s(h)			112
PC.49	PLC 15 segment acc./dec. time	0			112
PC.50	Running time unit	0			112
PC.51	MS command 0 reference mode	0			112
Pd	Communication function group: Pd.00-Pd.29				112
Pd.00	Baud rate	6005			112
Pd.01	Data format	0			113
Pd.02	Local address	1			113
Pd.03	Response delay	2			113
Pd.04	Excessive communication time	0.0			113
Pd.05	Data trans format selection	30			113
Pd.06	Communication read current resolution	0			114
PE	User customization function code: PE.00-PE.29				114
PE.00	User function code 0	P0.01			114
PE.01	User function code 1	P0.02			114
PE.02	User function code 2	P0.03			114
PE.03	User function code 3	P0.07			114
PE.04	User function code 4	P0.08			114
PE.05	User function code 5	P0.17			114
PE.06	User function code 6	P0.18			114
PE.07	User function code 7	P3.00			114
PE.08	User function code 8	P3.01			114
PE.09	User function code 9	P4.00			114

Appendix II Parameter Settings List

PE.10	User function code 10	P4.01			114
PE.11	User function code 11	P4.02			114
PE.12	User function code 12	P5.04			114
PE.13	User function code 13	P5.07			114
PE.14	User function code 14	P6.00			114
PE.15	User function code 15	P6.10			114
PE.16	User function code 16	P0.00			114
PE.17	User function code 17	P0.00			114
PE.18	User function code 18	P0.00			114
PE.19	User function code 19	P0.00			114
PE.20	User function code 20	P0.00			114
PE.21	User function code 21	P0.00			114
PE.22	User function code 22	P0.00			114
PE.23	User function code 23	P0.00			114
PE.24	User function code 24	P0.00			114
PE.25	User function code 25	P0.00			114
PE.26	User function code 26	P0.00			115
PE.27	User function code 27	P0.00			115
PE.28	User function code 28	P0.00			115
PE.29	User function code 29	P0.00			115
PP	Function code management: PP.00-PP.04				115
PP.00	User password	0			115
PP.01	Parameter initialization	0			115
PP.02	Parameter display attribute	11			116
PP.03	Personalized parameter display selection	00			116

Appendix II Parameter Settings List

PP.04	Function codes modification attribute	0			117
A0	Torque control group : A0.00-A0.08				117
A0.00	Speed/ torque control mode selection	0			117
A0.01	Torque setup source selection in torque control mode	0			117
A0.03	Torque digital setup in torque control mode	150%			117
A0.05	Torque control forward maximum frequency	50.00Hz			117
A0.06	Torque control Reserved maximum frequency	50.00Hz			117
A0.07	Torque control acc. time	0.00s			117
A0.08	Torque control dec. time	0.00s			118
A1	Virtual IO: A1.00-A1.21				118
A1.00	Virtual VDI1 function selection	0			118
A1.01	Virtual VDI2 function selection	0			118
A1.02	Virtual VDI3 function selection	0			118
A1.03	Virtual VDI4 function selection	0			118
A1.04	Virtual VDI5 function selection	0			118
A1.05	Virtual VD1 terminal valid state set mode	00000			118
A1.06	Virtual VD1 terminal state	00000			119
A1.07	AI1 as DI function selection	0			120
A1.08	AI2 as DI function selection	0			120
A1.09	AI3 as DI function selection	0			120
A1.10	AI as DI valid mode selection	000			120
A1.11	Virtual VDO1 output function	0			121
A1.12	Virtual VDO2 output function	0			121
A1.13	Virtual VDO3 output function	0			121

Appendix II Parameter Settings List

A1.14	Virtual VDO4 output function	0			121
A1.15	Virtual VDO5 output function	0			121
A1.16	VDO1 output delay time	0.0s			121
A1.17	VDO2 output delay time	0.0s			121
A1.18	VDO3 output delay time	0.0s			121
A1.19	VDO4 output delay time	0.0s			121
A1.20	VDO5 output delay time	0.0s			121
A1.21	VDO output terminal valid state selection	00000			121
A2	The second motor control: A2.00-A2.65				122
A2.00	Motor type selection	0			122
A2.01	Rated power	-			122
A2.02	Rated voltage	-			122
A2.03	Rated current	-			122
A2.04	Rated frequency	-			123
A2.05	Rated revolving speed	-			123
A2.06	Asynchronous motor stator resistance	-			123
A2.07	Asynchronous motor rotor resistance	-			123
A2.08	Asynchronous motor leakage inductance	-			123
A2.09	Asynchronous motor mutual inductance	-			123
A2.10	Asynchronous motor no load current	-			123
A2.16	Synchronous motor stator resistance	-			123
A2.17	Synchronous motor D-axis inductance	-			123
A2.18	Synchronous motor Q-axis inductance	-			123
A2.19	Synchronous motor inductance resistance unit	0			123

Appendix II Parameter Settings List

A2.20	Synchronous motor back electromotive force coefficient.	0.1V			123
A2.21	Synchronous motor output phase lack detection time	0			123
A2.27	Encoder pulses number	2500			123
A2.28	Encoder type	0			123
A2.29	Speed feedback PG selection	0			123
A2.30	ABZ incremental encoder AB phase	0			123
A2.31	Encoder installation angle	0			123
A2.32	UVW phase sequence	0			123
A2.33	UVW encoder offset angle	0.00			123
A2.34	Rotary transformer pole pairs	1			123
A2.35	UVW pole-pairs	4			124
A2.36	PG dropped inspection time	0.0s			124
A2.37	Tuning selection	0			124
A2.38	Speed loop proportional gain 1	30			124
A2.39	Speed loop integration time 1	0.50s			124
A2.40	Switching frequency1	5.00Hz			124
A2.41	Speed loop proportional gain 2	20			124
A2.42	Speed loop integration time 2	1.00s			124
A2.43	Switching frequency 2	10.00Hz			124
A2.44	Vector control slip gain	150%			124
A2.45	Speed-loop filtering time	0.000s			124
A2.46	Vector control over-excitation gain	64			124
A2.47	Torque upper limit source in speed control mode	0			124
A2.48	Torque upper limit digital setup in speed control mode	150.0%			124

Appendix II Parameter Settings List

A2.51	Excitation regulation proportional gain	2000			124
A2.52	Excitation regulation integration gain	1300			124
A2.53	Torque regulation proportional gain	2000			124
A2.54	Torque regulation integration gain	1300			124
A2.55	Speed loop integration attribute	0			125
A2.56	Synchronous motor field weakening mode	1			125
A2.57	Synchronous motor field weakening depth	100%			125
A2.58	Maximum field weakening current	50%			125
A2.59	Field weakening auto regulation gain	100%			125
A2.60	Field weakening integration multiples	2			125
A2.61	Motor 2 control mode	0			125
A2.62	Motor 2 acc./dec. time selection	0			125
A2.63	Motor 2 torque hoist	-			125
A2.65	Motor 2 oscillation suppression gain	-			125
A5	Control optimization group: A5.00-A5.11				131
A5.00	DPWM switching frequency upper limit	12.00Hz			131
A5.01	PWM modulation mode	0			132
A5.02	Dead-zone compensation mode selection	1			132
A5.03	Random PWM depth	0			132
A5.04	Rapid current-limiting enable	1			132
A5.05	Voltage over modulation coefficient	5			132
A5.06	Under-voltage point setup	350			132
A5.08	Low speed carrier frequency	0			133
A5.09	Over-voltage point setup	Model determinat ion			133
A5.11	Dc injection braking threshold at low speed	0.30			

Appendix II Parameter Settings List

A6	AI curve setup: A6.00-A6.29				133
A6.00	AI curve 4 minimum input	0.00V			133
A6.01	AI curve 4 minimum input corresponding setup	0.0%			133
A6.02	AI curve 4 inflection point 1 input	3.00V			133
A6.03	AI curve 4 inflection point 1 input corresponding setup	30.0%			133
A6.04	AI curve 4 inflection point 2 input	6.00V			133
A6.05	AI curve 4 inflection point 2 input corresponding setup	60.0%			133
A6.06	AI curve 4 maximum input	10.00V			133
A6.07	AI curve 4 maximum input corresponding setup	100.0%			133
A6.08	AI curve 4 minimum input	-10.00V			133
A6.09	AI curve 5 minimum input corresponding setup	-100.0%			133
A6.10	AI curve 5 inflection point 1 input	-3.00V			133
A6.11	AI curve 5 inflection point 1 input corresponding setup	-30.0%			133
A6.12	AI curve 5 inflection point 2 input	3.00V			133
A6.13	AI curve 5 inflection point 2 input corresponding setup	30.0%			133
A6.14	AI curve 5 maximum input	10.00V			133
A6.15	AI curve 5 maximum input corresponding setup	100.0%			133
A6.24	AI1 set hopping point	0.0%			134
A6.25	AI1 set hopping amplitude	0.5%			134
A6.26	AI2 set hopping point	0.0%			134
A6.27	AI2 set hopping amplitude	0.5%			134
A6.28	AI3 set hopping point	0.0%			134
A6.29	AI3 set hopping amplitude	0.5%			134
A7	User programmable card parameters: A7.00-A7.09				134

Appendix II Parameter Settings List

A7.00	User programmable function selection	0			134
A7.01	Control board output terminal control mode selection	-			134
A7.02	Programmable card expansion AI3x function configuration	-			135
A7.03	FMP output	0.0%			135
A7.04	AO1 output	0.0%			135
A7.05	Switch output	000			135
A7.06	Programmable card frequency setup	0.0%			135
A7.07	Programmable card torque setup	0.0%			135
A7.08	Programmable card command setup	0			135
A7.09	Programmable card fault setup	0			135
A8	Point to point communication : A8.00-8.11				
A8.00	Master slave control function selection	0			
A8.01	Master slave selection	0			
A8.02	Master slave information exchange	011			
A8.03	Message frame selection	0			
A8.04	Receive data zero offset torque	0.00%			
A8.05	Receive data gain torque	1.00			
A8.06	Communication interrupt detection time	1.0s			
A8.07	Communication Master data transmission cycle	0.001s			
A8.08	Receive data zero offset frequency	0.00%			
A8.09	Receive data gain frequency	1.00			
A8.10	Reserved				
A8.11	view	0.5Hz			
A9	Extended function group: A9.00-A9.09				135

Appendix II Parameter Settings List

A9.00	Reserved	0			135
A9.01	Reserved	0			136
A9.02	Reserved	0			136
A9.03	Reserved	0			136
A9.04	Reserved	0			136
A9.05	Reserved	0			136
A9.06	Reserved	0			136
A9.07	Reserved	0			136
A9.08	Reserved	0			136
A9.09	Reserved	0			136
AC	AIAO correction: AC.00-AC.19				136
AC.00	AI1 measured voltage 1	Factory calibration			136
AC.01	AI1 display voltage 1	Factory calibration			136
AC.02	AI1 measured voltage 2	Factory calibration			136
AC.03	AI1 display voltage 2	Factory calibration			136
AC.04	AI2 measured voltage 1	Factory calibration			136
AC.05	AI2 display voltage 1	Factory calibration			136
AC.06	AI2 measured voltage 2	Factory calibration			136
AC.07	AI2 display voltage 2	Factory calibration			136
AC.08	AI3 measured voltage 1	Factory calibration			136

Appendix II Parameter Settings List

AC.09	A13 display voltage 1	Factory calibration			136
AC.10	A13 measured voltage 2	Factory calibration			136
AC.11	A13 display voltage 2	Factory calibration			136
AC.12	A01 target voltage 1	Factory calibration			137
AC.13	A01 measured voltage 1	Factory calibration			137
AC.14	A01 target voltage 2	Factory calibration			137
AC.15	A01 measured voltage 2	Factory calibration			137
AC.16	A02 target voltage 1	Factory calibration			137
AC.17	A02 measured voltage 1	Factory calibration			137
AC.18	A02 target voltage 2	Factory calibration			137
AC.19	A02 measured voltage 2	Factory calibration			137

Appendix III Recommended accessories selection

1.Brake unit braking resistor selection:

Motor adapter	Brake unit model	Number of brake units	Resistance configuration	Resistance quantity	brake torque(10%ED)%
0.40	inverter inlay		70W 750Ω	1	230
0.75	inverter inlay		100W 300Ω	1	130
1.5	inverter inlay		200W 300Ω	1	125
2.2	inverter inlay		200W 200Ω	1	135
3.7	inverter inlay		400W 150Ω	1	135
5.5	inverter inlay		500W 100Ω	1	135
7.5	inverter inlay		800W 75Ω	1	130
11	inverter inlay		1000W 60Ω	1	135
15	inverter inlay		1560W 45Ω	1	125
18.5	inverter inlay		4800W 32Ω	1	125
22	inverter inlay		4800W 27.2Ω	1	125
30	DBU-4030	1	6000W 20Ω	1	125
37	DBU-4045	1	9600W 16Ω	1	125
45	DBU -4045	1	9600W 13.6Ω	1	125
55	DBU -4030	2	6000W 20Ω	2	135
75	DBU -4045	2	9600W 13.6Ω	2	145
110	DBU -4030	3	9600W 20Ω	3	100
160	DBU -4220	1	40KW 3.4Ω	1	140
220	DBU -4220	1	60KW 3.2Ω	1	110
300	DBU -4220	2	40KW4.5Ω	2	110

600	DBU -4220	4	40KW 4.5Ω	4	110
-----	-----------	---	-----------	---	-----

2. Input AC reactor

Motor power	Input reactor model	Shape dimension W*D*H (mm)	Installation dimension (mm)	Note
0.75	HSG10A/5V-4007	140*85*140	75*55Φ6	
1.5	HSG10A/5V-4015	140*85*140	75*55Φ6	
2.5	HSG10A/5V-4022	140*85*140	75*55Φ6	
4	HSG15A/5V-4037	140*85*140	75*55Φ6	
5.5	HSG15A/5V-4055	140*85*140	75*55Φ6	
7.5	HSG20A/5V-4075	175*130*140	82*75Φ6	
11	HSG30A/5V-4110	175*130*140	82*75Φ6	
15	HSG40A/5V-4150	210*120*190	110*70Φ8	
18	HSG50A/5V-4180	210*120*190	110*70Φ8	
22	HSG60A/5V-4220	210*165*170	110*85Φ8	
30	HSG80A/5V-4300	210*165*170	110*85Φ8	
37	HSG110A/5V-4370	210*165*170	110*85Φ8	
45	HSG125A/5V-4450	210*165*170	110*85Φ8	
55	HSG150A/5V-4550	270*170*220	155*85Φ10	
75	HSG200A/5V-4750	290*190*255	170*85Φ10	
93	HSG250A/5V-4930	290*190*230	170*105Φ10	
110	HSG275A/5V-41100	290*190*230	170*105Φ10	
132	HSG330A/5V-41320	320*240*230	193*130Φ10	
160	HSG450A/5V-41600	330*210*290	193*130Φ10	

185	HSG500A/5V-41850	330*210*290	193*130Φ10	
200	HSG510A/5V-42000	330*210*290	193*130Φ10	
220	HSG540A/5V-42200	330*210*290	193*130Φ10	
250	HSG625A/5V-42500	330*220*290	193*140Φ10	
315	HSG800A/5V-43150	330*240*290	193*150Φ10	
375	HSG1000A/5V-43750	350*280*290	193*150Φ10	
400	HSG1100A/5V-44000	350*280*290	193*150Φ10	

3. Output AC reactor

Motor power KW	Output reactor model	Shape dimension W*D*H (mm)	Installation dimension (mm)	Note
0.75	HSG10A/9V-4007	140*85*140	75*55Φ6	
1.5	HSG10A/9V-4015	140*85*140	75*55Φ6	
2.5	HSG10A/9V-4022	140*85*140	75*55Φ6	
4	HSG15A/9V-4037	140*85*140	75*55Φ6	
5.5	HSG15A/9V-4055	140*85*140	75*55Φ6	
7.5	HSG20A/9V-4075	140*85*140	75*55Φ6	
11	HSG30A/9V-4110	210*165*170	110*85Φ8	
15	HSG40A/9V-4150	210*165*170	110*85Φ8	
18	HSG50A/9V-4180	210*165*170	110*85Φ8	
22	HSG60A/9V-4220	210*165*170	110*85Φ8	
30	HSG80A/9V-4300	270*190*230	155*100Φ10	
37	HSG110A/9V-4370	270*190*230	155*100Φ10	
45	HSG125A/9V-4450	270*190*230	155*100Φ10	
55	HSG150A/9V-4550	290*200*230	170*115Φ10	
75	HSG200A/9V-4750	300*230*230	173*135Φ10	

93	HSG250A/9V-4930	330*230*230	190*130Φ10	
110	HSG275A/9V-41100	330*230*230	190*130Φ10	
132	HSG330A/9V-41320	340*230*230	212*130Φ10	
160	HSG450A/9V-41600	330*220*290	193*140Φ10	
185	HSG500A/9V-41850	330*220*290	193*140Φ10	
200	HSG510A/9V-42000	330*220*290	193*140Φ10	
220	HSG540A/9V-42200	330*220*290	193*140Φ10	
250	HSG625A/9V-42500	350*280*290	193*150Φ10	
315	HSG800A/9V-43150	350*280*290	193*150Φ10	
375	HSG1000A/9V-43750	400*300*350	240*200Φ10	
400	HSG1100A/9V-44000	400*300*350	240*200Φ10	

